



# Zubehör

## Accessories

## Accessoires

## Yedekler

INHALTSVERZEICHNIS / INDEX	Seite / Page
<b>Spannfutter - Collet chuck</b> Mandrin á princes - Pens başlığı	9.01 - 9.02
<b>Schrumpfverlängerungen - Shrink fit extensions</b> Allonge - Silindirik ısıtmalı takım tutucu	9.03
<b>Fräsdorne für Einschraubfräser - Milling cutter arbors</b> Axes coupeur fraisege - Vidalı tip silindirik takım tutucu	9.04 - 9.05
<b>Reduzierungen für Einschraubfräser - Reducing for mill. cutter</b> Extension pour vis - Vidalı tip frezeler için ara adaptör	9.05 - 9.06
<b>Gewindeschneidfutter - Quick change tapping chuck</b> Appareil á tarauder - Kılavuz çekme başlığı	9.06
<b>Sägeblattaufnahme - Saw blade holder</b> Porte-lame de scie - Daire testere tutucu	9.07
<b>Reduziereinsätze - Reducing bushings</b> Réduction - Silindirik şaftlı redüksiyon	9.07
<b>Spannzangen - Collets</b> Pinces de serrage - Pensler	9.08 - 9.18
<b>Spannzangen mit Präzisionskraftspannfutter - Collet EKS</b> Pinces EKS - Bilyalı pens tutucu pensi	9.19
<b>Reduzierungen für Hydrodehn - Redcing arbor for hydraulic</b> Douille de réduction hydrauliques - Hidrolik takım tutucu pensi	9.20 - 9.21
<b>Spannzangensatz in Koffer - Collet set in box</b> set de pince dans valise - Pens takımı plastik kutuda	9.22 - 9.23
<b>Spannmutter - Clamping nuts</b> Écrou de serrage - Pens kapağı	9.24 - 9.26
<b>Dichtscheiben für Spannmuttern - Sealing for clamping Nuts</b> Joints écrou de serrage - Su sızdırmazlık ringi kapaklar için	9.27
<b>Reduzierbüchse für Bohrstangenhalter - Reduction bushes</b> Douille de réduction - Delik kateri redüksiyonu	9.28 - 9.30
<b>Anzugsbolzen - Pull studs</b> Tirettes - Çektirme civataları	9.31 - 9.33
<b>Einsätze mit Rutschkupplung - Tapping collets</b> Douille limiteur - Kılavuz tutucu	9.34 - 9.36
<b>Gewindebohrerhalter - Tap holder</b> Porte-taraud - Silinirik şaftlı kılavuz tutucu	9.37
<b>Spannschrauben - Clamping screw</b> Vis de serrage - Sıkma civatası	9.38 - 9.40





# Zubehör

Accessories

Accessoires

Yedekler

## INHALTSVERZEICHNIS / INDEX

Seite / Page

Anschlagschraube - Stop screw

Vis ajuster - Dayama civatası

9.41 - 9.43

Paßfeder - Feather key

Ressort de passage - Kama

9.44

Mitnehmersteine mit Schraube - Drive key

Entraîneur - Vidalı kama

9.44

Unterlegplatte - Shim

Plaque entretoise - Kater laması

9.44

Fräseranzugschrauben DIN6367 - Drawn in bolt DIN6367

Vis de serrage DIN6367 - Tarama başlık sıkma civatası DIN6367

9.45

Mitnehmerringe DIN6366 - Clutch drive rings DIN6366

Bague d'entraînement DIN6366 - Tınaklı pul DIN6366

9.46

Schraubenschlüssel - Wrenches

Clés - Anahtarlar

9.46 - 9.49

Bohrfutter - Drill chuck

Mandrin de peçage à serrage - Süper supra mandren

9.49

Kühlmittelübergabeeinheit - Delivery unit for coolant

Unité de transmission de liquide - Soğutma suyu ünitesi

9.50

Kunststoff-Kugelspritzdüse - Ball sprayer nozzle

Buse d'injection spherique - Su verme misketi

9.50 - 9.51

Kegelwischer - Taper wiper

Cônes de nettoyage - Konik temizleyici

9.51

Montage blocks - Assembly blocks

Blocs de montage - Montaj aparatları

9.52 - 9.54

NC-Bohrfutter mit MK schaft - NC drill chuck with MK shaft

Mandrin de peçage CNC avec cône morse - MK şaftı NC mandren malafası

9.54

Bohrfutter Köpfe - Drill heads

Tete de peçage - Madren

9.55 - 9.57

Tischwerkzeuggestell - Benchtop tool shelf

Support de table pour outils - Takım sehpası ve arabası

9.58 - 9.59



## Spannfutter mit Zylinderschaft durchbohrt



Collet chuck with cylindrical shank bored through

Mandrin á princes á quene cylindrique percee

Silindirik Şaftlı Pens Başlıkları

Bestell-Nr. Order Nr. Référéce Sipariş Nr.	d	Spannbereich Capacity Capacité Kapasite	L	L1	D	Euro
<b>new</b> 120.0205.12.50.M	12	ER 8 Mini (1-5)	50	24	12	
<b>new</b> 120.0205.12.100.M	12	ER 8 Mini (1-5)	100	24	12	
<b>new</b> 120.0205.12.150.M	12	ER 8 Mini (1-5)	150	24	12	
<b>new</b> 120.0207.12.50.M	12	ER 11 Mini (1-7)	50	25	16	
120.0207.12.100.M	12	ER 11 Mini (1-7)	100	25	16	
120.0207.12.150.M	12	ER 11 Mini (1-7)	150	25	16	
<b>new</b> 120.0207.16.50.M	16	ER 11 Mini (1-7)	50	25	16	
<b>new</b> 120.0207.16.100.M	16	ER 11 Mini (1-7)	100	25	16	
<b>new</b> 120.0207.16.150.M	16	ER 11 Mini (1-7)	150	25	16	
<b>new</b> 120.0210.16.60.M	16	ER 16 Mini (1-10)	60	30	22	
<b>new</b> 120.0210.16.100.M	16	ER 16 Mini (1-10)	100	30	22	
<b>new</b> 120.0210.16.150.M	16	ER 16 Mini (1-10)	150	30	22	
<b>new</b> 120.0210.20.60.M	20	ER 16 Mini (1-10)	60	30	22	
<b>new</b> 120.0210.20.100.M	20	ER 16 Mini (1-10)	100	30	22	
<b>new</b> 120.0210.20.150.M	20	ER 16 Mini (1-10)	150	30	22	

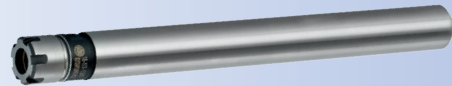

### INFO

Technische Daten	10.01
Technical Data	10.01
Donées Techniques	10.01
Teknik Bilgi	10.01

### Zubehör / Accessories / Accessoires / Yedekler

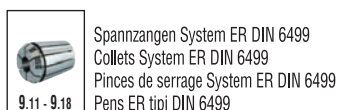



## Spannfutter mit Zylinderschaft durchbohrt

Collet chuck with cylindrical shank bored through

Mandrin á princes á quene cylindrique percee

Silindirik Şaftlı Pens Başlıkları

Bestell-Nr. Order Nr. Référence Sipariş Nr.	d	Spannbereich Capacity Capacité Kapasite	L	L1	D	Euro
<b>new</b> 120.0210.16.60	16	ER 16 (1-10)	60	30	28	
<b>new</b> 120.0210.16.100	16	ER 16 (1-10)	100	30	28	
120.0210.16.150	16	ER 16 (1-10)	150	30	28	
<b>new</b> 120.0210.20.60	20	ER 16 (1-10)	60	30	28	
<b>new</b> 120.0210.20.100	20	ER 16 (1-10)	100	30	28	
<b>new</b> 120.0210.20.150	20	ER 16 (1-10)	150	30	28	
<b>new</b> 120.0210.25.60	25	ER 16 (1-10)	60	35	28	
<b>new</b> 120.0210.25.100	25	ER 16 (1-10)	100	35	28	
<b>new</b> 120.0210.25.150	25	ER 16 (1-10)	150	35	28	
<b>new</b> 120.0216.20.60	20	ER 25 (2-16)	60	40	42	
<b>new</b> 120.0216.20.100	20	ER 25 (2-16)	100	40	42	
120.0216.20.150	20	ER 25 (2-16)	150	40	42	
<b>new</b> 120.0216.25.60	25	ER 25 (2-16)	60	50	42	
<b>new</b> 120.0216.25.100	25	ER 25 (2-16)	100	50	42	
<b>new</b> 120.0216.25.150	25	ER 25 (2-16)	150	50	42	
<b>new</b> 120.0216.32.60	32	ER 25 (2-16)	60	50	42	
<b>new</b> 120.0216.32.100	32	ER 25 (2-16)	100	50	42	
<b>new</b> 120.0216.32.150	32	ER 25 (2-16)	150	50	42	
<b>new</b> 120.0220.20.60	20	ER 32 (2-20)	60	53	50	
<b>new</b> 120.0220.20.100	20	ER 32 (2-20)	100	53	50	
<b>new</b> 120.0220.20.150	20	ER 32 (2-20)	150	53	50	
<b>new</b> 120.0220.25.60	25	ER 32 (2-20)	60	53	50	
<b>new</b> 120.0220.25.100	25	ER 32 (2-20)	100	53	50	
<b>new</b> 120.0220.25.150	25	ER 32 (2-20)	150	53	50	
<b>new</b> 120.0220.32.60	32	ER 32 (2-20)	60	53	50	
<b>new</b> 120.0220.32.100	32	ER 32 (2-20)	100	53	50	
120.0220.32.150	32	ER 32 (2-20)	150	53	50	
<b>new</b> 120.0220.40.100	40	ER 32 (2-20)	100	30	50	
<b>new</b> 120.0220.40.150	40	ER 32 (2-20)	150	30	50	
<b>new</b> 120.0226.32.70	32	ER 40 (2-26)	70	63	63	
<b>new</b> 120.0226.32.100	32	ER 40 (2-26)	100	63	63	
<b>new</b> 120.0226.32.150	32	ER 40 (2-26)	150	63	63	
<b>new</b> 120.0226.40.70	40	ER 40 (2-26)	70	63	63	
<b>new</b> 120.0226.40.100	40	ER 40 (2-26)	100	63	63	
<b>new</b> 120.0226.40.150	40	ER 40 (2-26)	150	63	63	

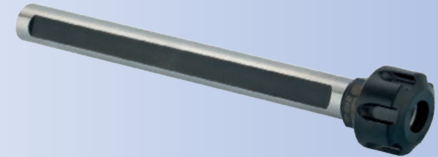

ER 16

Lieferumfang : Inkl. Spannmutter  
Included : Clamping nut  
Inclus : Écrou de serrage  
Teslim Şekli : Kapak ile birlikte

### INFO

Technische Daten	10.01
Technical Data	10.01
Donées Techniques	10.01
Teknik Bilgi	10.01

### Zubehör / Accessories / Accessoires / Yedekler



Spannzangen System ER DIN 6499  
Collets System ER DIN 6499  
Pince de serrage System ER DIN 6499  
Pens ER tipi DIN 6499



Spannmutter ER DIN 6499  
Clamping nuts ER DIN 6499  
Écrou de serrage ER DIN 6499  
Pens kapağı ER DIN 6499



Spannchlüssel für ER  
Wrench ER  
Clé de serrage ER  
ER tipi anahtar

## Schrumpfverlängerungen



### Shrink fit extensions

#### Allonge

#### Silindirik Isıtmalı takım tutucu

Bestell-Nr. Order Nr. Référence Sipariş Nr.	D	d1	d2	A	L1	L2	L3	M	Euro
120.25.12.03.150	12	3	8	150	-	-	12	M5	
120.25.12.04.150	12	4	8	150	-	-	16	M5	
120.25.16.03.150	16	3	10	150	-	-	12	M5	
120.25.16.04.150	16	4	10	150	-	-	16	M5	
120.25.16.05.150	16	5	10	150	-	-	20	M6	
120.25.16.06.150	16	6	10	150	36	10	26	M5	
120.25.20.03.150	20	3	10	150	-	-	12	M5	
120.25.20.04.150	20	4	10	150	-	-	16	M5	
120.25.20.05.150	20	5	10	150	-	-	20	M6	
120.25.20.06.150	20	6	10	150	36	10	26	M5	
120.25.20.08.150	20	8	12	150	36	10	26	M6	
120.25.20.10.150	20	10	14	150	42	10	32	M6	
120.25.20.12.150	20	12	16	150	47	10	37	M10	
120.25.25.08.150	25	8	20	150	36	10	26	M6	
120.25.25.10.150	25	10	20	150	42	10	32	M6	
120.25.25.12.150	25	12	20	150	47	10	37	M10	
120.25.25.14.150	25	14	20	150	47	10	37	M10	
120.25.25.16.150	25	16	22	150	50	10	40	M10	
120.25.32.10.150	32	10	24	150	42	10	32	M6	
120.25.32.12.150	32	12	24	150	47	10	37	M10	
120.25.32.14.150	32	14	27	150	47	10	37	M10	
120.25.32.16.150	32	16	27	150	50	10	40	M10	
120.25.32.18.150	32	18	27	150	50	10	40	M10	
120.25.32.20.150	32	20	27	150	52	10	42	M10	

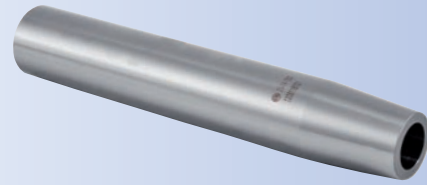
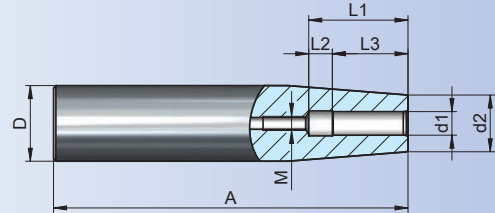

### INFO

Technische Daten	10.08
Technical Data	10.08
Donées Techniques	10.08
Teknik Bilgi	10.08



## Fräsdorne für Einschraubfräser Zylinderschäfte

Milling Cutter Arbors for Screw-on type Milling Cutters

Axes Coupeur Fraisage Pour Vis-Sur Type Coupeurs de Fraisage

Vidalı tip frezeler için Silindirik Şaftlı Takım Tutucular

Bestell-Nr. Order Nr. Référence Sipariş Nr.	D	M	d1	d2	d3	A	L	Euro
120.12.12.M05.020	12	M5	5,5	10	12	20	65	
120.12.20.M06.025	20	M6	6,5	10	18	25	75	
120.12.20.M06.050	20	M6	6,5	10	18	50	100	
120.12.20.M06.075	20	M6	6,5	10	18	75	125	
120.12.16.M08.040	16	M8	8,5	13	16	40	88	
120.12.20.M08.025	20	M8	8,5	13	18	25	75	
120.12.20.M08.050	20	M8	8,5	13	18	50	100	
120.12.20.M08.075	20	M8	8,5	13	18	75	125	
120.12.20.M10.025	20	M10	10,5	18	18	25	75	
120.12.20.M10.025.1	20	M10	10,5	18	20	25	80	
120.12.20.M10.050	20	M10	10,5	18	18	50	100	
120.12.20.M10.075	20	M10	10,5	18	18	75	125	
120.12.20.M10.097	20	M10	10,5	18	20	97	152	
120.12.25.M12.025	25	M12	12,5	21	25	25	81	
120.12.25.M12.040	25	M12	12,5	21	25	40	101	
120.12.25.M12.075	25	M12	12,5	21	25	75	131	
120.12.25.M12.109	25	M12	12,5	21	25	109	170	
120.12.25.M12.125	25	M12	12,5	21	25	125	181	
120.12.32.M12.105	32	M12	12,5	21	25	105	170	
120.12.32.M16.025	32	M16	17	29	32	25	85	
120.12.32.M16.040	32	M16	17	29	32	40	105	
120.12.32.M16.075	32	M16	17	29	32	75	135	
120.12.32.M16.125	32	M16	17	29	32	125	185	

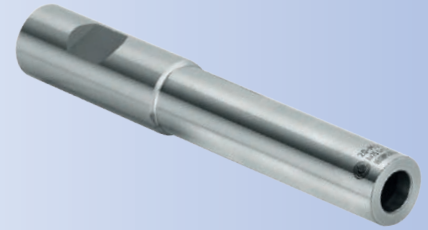
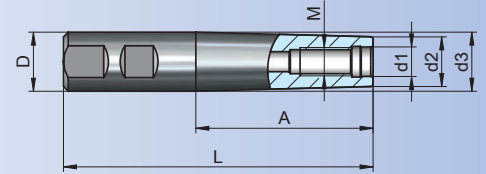

### INFO

Technische Daten	10.08
Technical Data	10.08
Donées Techniques	10.08
Teknik Bilgi	10.08

Empfohlene Anzugsmomente  
Recommended tightening torques  
Torques de serrage recommandés  
Önerilen sıkma torku

M6	10 Nm
M8	25 Nm
M10	40 Nm
M12	60 Nm
M16	80 Nm



## Fräsdorne für Einschraubfräser Zylinderschäfte

Milling Cutter Arbors for Screw-on type Milling Cutters

Axes Coupeur Fraisage Pour Vis-Sur Type Coupeurs de Fraisage

Vidalı tip frezeler için Silindirik Şaftlı Takım Tutucular

Bestell-Nr. Order Nr. Référence Sipariş Nr.	D	M	d1	d2	L1	A	L	Euro
123.12.20.M10.067	20	M10	10,5	18	67	68,7	160	
123.12.25.M12.077	25	M12	12,5	21	77	87,5	240	
123.12.32.M12.023	32	M12	12,5	21	23	54	160	
123.12.32.M12.059	32	M12	12,5	21	59,5	134	300	
123.12.32.M16.066	32	M16	17	29	66	68,7	160	
123.12.32.M16.146	32	M16	17	29	146	148,7	300	

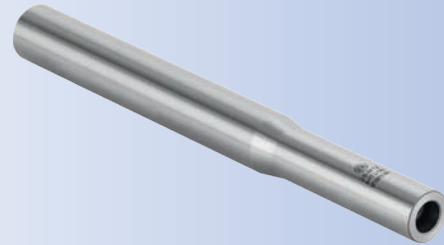
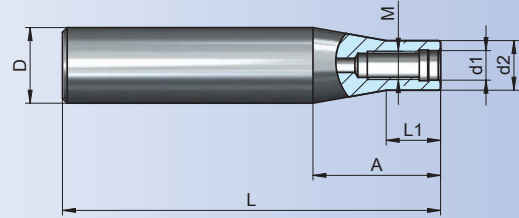

Empfohlene Anzugsmomente  
Recommended tightening torques  
Torques de serrage recommandés  
Önerilen sıkma torku

M6	10 Nm
M8	25 Nm
M10	40 Nm
M12	60 Nm
M16	80 Nm

## Verlängerungen für Einschraubfräser

Extensions for milling cutter arbors

Extension pour - sur - type coupeurs de fraisage

Vidalı tip frezeler için ara adaptör

Bestell-Nr. Order Nr. Référence Sipariş Nr.	D	M	d1	L	Euro
124.12.13.M08.030	13	M8	8,5	30	
124.12.18.M10.035	18	M10	10,5	35	
124.12.21.M12.040	21	M12	12,5	40	
124.12.29.M16.040	29	M16	17	40	

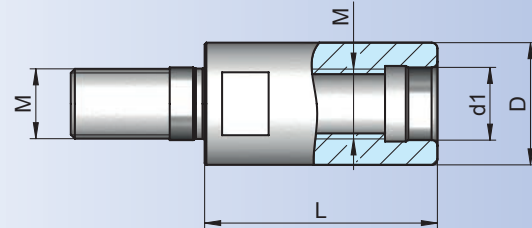



## Reduzierungen für Einschraubfräser

Reducing for milling cutter arbors

Extension pour vis - sur - type coupeurs de fraisage

Vidalı tip frezeler için ara adaptör

Bestell-Nr. Order Nr. Référence Sipariş Nr.	D	M x M1	d1	d2	d3	L	Euro
126.12.13.M0608.030	13	M6/M8	5,5	10	8,5	30	
126.12.18.M0810.030	18	M8/M10	8,5	13	10,5	30	
126.12.21.M1012.035	21	M10/M12	10,5	18	12,5	35	
126.12.29.M1016.060	29	M10/M16	10,5	18	17	60	
126.12.29.M1216.060	29	M12/M16	12,5	21	17	60	

Empfohlene Anzugsmomente  
Recommended tightening torques  
Torques de serrage recommandés  
Önerilen sıkma torku

M6	10 Nm
M8	25 Nm
M10	40 Nm
M12	60 Nm
M16	80 Nm

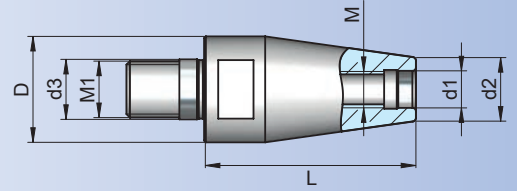

## Gewindeschneid - Schnellwechselfutter mit Längenausgleich auf Druck und Zug

Quick-change tapping chucks with length compensation

Appareil à tarauder avec compensation longitudinale

Kılavuz çekme başlığı giri ve çıkış kompanzeli

Bestell-Nr. Order Nr. Référence Sipariş Nr.	D1	Spannbereich Capacity Capacité Kapasite	d	A	D	L	C	T	Euro
<b>new</b> 120.16.12.20.41	20	M2-M14	19	41	36,5	50	7	7	
<b>new</b> 120.16.12.25.41	25	M2-M14	19	41	36,5	50	7	7	
<b>new</b> 120.16.12.32.41	32	M2-M14	19	41	36,5	61	7	7	
<b>new</b> 120.16.12.40.41	40	M2-M14	19	41	36,5	68	7	7	
<b>new</b> 120.16.20.20.75	20	M5-M24	31	75	53,5	50	12	12	
<b>new</b> 120.16.20.25.75	25	M5-M24	31	75	53,5	50	12	12	
<b>new</b> 120.16.20.32.75	32	M5-M24	31	75	53,5	61	12	12	
<b>new</b> 120.16.20.40.75	40	M5-M24	31	75	53,5	68	12	12	
<b>new</b> 120.16.36.40.115	40	M14-M36	48	115	78	68	17,5	17,5	

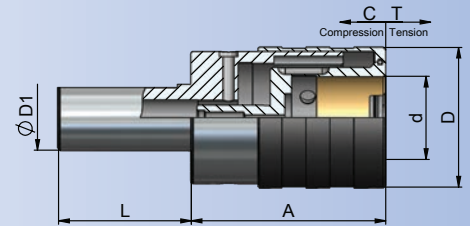

## Zubehör / Accessories / Accessoires / Yedekler



Schnellwechseleinsätze  
Tapping collets  
Douilles de taraudage  
Kılavuz tutucu

9.06



## Sägeblattaufnahme



### Saw blade holder

### Porte - lame de scie

### Daire testere tutucu

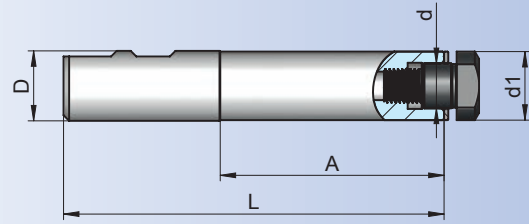

Bestell-Nr. Order Nr. Référence Sipariş Nr.	Sägeblatt Ø	D	d1	d	A	L	Euro
121.20.05.040	20	20	10	5	40	90	
121.20.08.055	25/32	20	13	8	55	105	
121.20.10.060	40	20	20	10	60	110	
121.25.13.080	50	25	25	13	80	135	
121.25.16.080	63	25	25	16	80	135	

Lieferumfang : Inkl. Spannschraube und Zwischenring  
Included : Clamping screw and washer  
Inclus : Vis de serrage et bague intermédiaire  
Teslim Şekli : Sıkma civatası ve pulu ile birlikte

Verwendung : Zur Aufnahme von Sägeblättern in Fräseraufnahmen oder Spannfutter  
Application : For saw blade holders in end mill holder and collet chuck  
Emploi : Pour la réception de lames de scie dans des porte-fraises ou des porte-pinces  
Kullanma Yeri : Veldon tutuculara ve pens başlığına bağlamak için daire testere malafası

## Reduziereinsätze DIN 1835 B für Zylinderschäfte DIN 1835 E

### Reducing bushings DIN 1835 B for cylindrical shanks DIN 1835E

### Réduction DIN 1835 B pour queue cylindriques DIN 1835 E

### Redüksiyon DIN 1835 B Silindirik şaftlı DIN 1835 E

Bestell-Nr. Order Nr. Référence Sipariş Nr.	d	d1	D	L	Euro
122.20.06.030	20	6	25	30	
122.20.08.030	20	8	28	30	
122.20.10.030	20	10	35	30	
122.20.12.035	20	12	42	35	

122.32.06.030	32	6	25	30	
122.32.08.030	32	8	28	30	
122.32.10.030	32	10	35	30	
122.32.12.035	32	12	42	35	
122.32.14.035	32	14	44	35	
122.32.16.038	32	16	48	38	
122.32.18.038	32	18	50	38	
122.32.20.040	32	20	52	40	

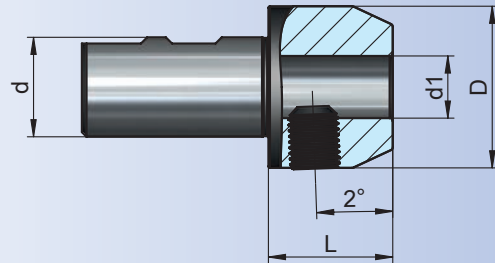

## Zubehör / Accessories / Accessoires / Yedekler



Spannschrauben DIN 1835 B  
Clamping screw DIN 1835 B  
Vis de serrage DIN 1835 B  
Sıkma civatası DIN 1835 B



Einstellschraube DIN 916  
Adjusting screw DIN 916  
Vis de réglage DIN 916  
Dayama civatası DIN 916



**Collets DIN 6388 B**

**Pinces de serrage DIN 6388, forme B**

**Pensler DIN 6388 B Formu**

Bestell-Nr. Order Nr. Réf�rence Sipariř Nr.	d	D	L	Euro
415 E-02	2	25,5	40	
415 E-03	3	25,5	40	
415 E-04	4	25,5	40	
415 E-05	5	25,5	40	
415 E-06	6	25,5	40	
415 E-07	7	25,5	40	
415 E-08	8	25,5	40	
415 E-09	9	25,5	40	
415 E-10	10	25,5	40	
415 E-11	11	25,5	40	
415 E-12	12	25,5	40	
415 E-13	13	25,5	40	
415 E-14	14	25,5	40	
415 E-15	15	25,5	40	
415 E-16	16	25,5	40	

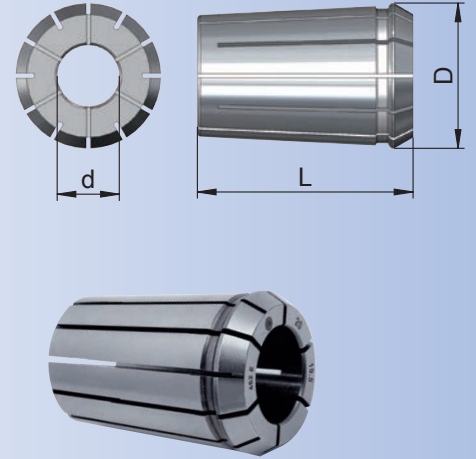

Spanntoleranz : - 0,5 mm  
Clamping capacity : - 0,5 mm  
Capacit  de serrage : - 0,5 mm  
Sikma kapasitesi : - 0,5 mm

Rundlaufgenauigkeit : 6 m  
Concentricity : 6 m  
Concentricit  : 6 m  
Konsantriklik : 6 m

Komplettsatz : Seite 9.22  
Complete set : Page 9.22  
Kit complet : Voir page 9.22  
Komple set : Sayfa 9.22



## Collets DIN 6388 B

## Pinces de serrage DIN 6388, forme B

## Pensler DIN 6388 B Formu

Bestell-Nr. Order Nr. Référence Sipariş Nr.	d	D	L	Euro
462 E-02	2	35,05	52	
462 E-03	3	35,05	52	
462 E-04	4	35,05	52	
462 E-05	5	35,05	52	
462 E-06	6	35,05	52	
462 E-07	7	35,05	52	
462 E-08	8	35,05	52	
462 E-09	9	35,05	52	
462 E-10	10	35,05	62	
462 E-11	11	35,05	52	
462 E-12	12	35,05	52	
462 E-13	13	35,05	52	
462 E-14	14	35,05	52	
462 E-15	15	35,05	52	
462 E-16	16	35,05	52	
462 E-17	17	35,05	52	
462 E-18	18	35,05	52	
462 E-19	19	35,05	52	
462 E-20	20	35,05	52	
462 E-21	21	35,05	52	
462 E-22	22	35,05	52	
462 E-23	23	35,05	52	
462 E-24	24	35,05	52	
462 E-25	25	35,05	52	

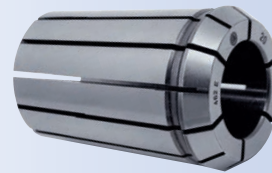
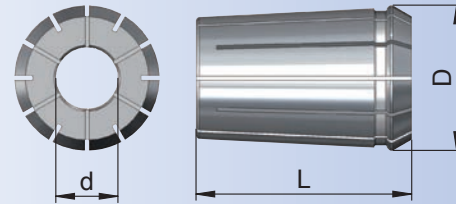

Spanntoleranz : - 0,5 mm  
Clamping capacity : - 0,5 mm  
Capacité de serrage : - 0,5 mm  
Sıkma kapasitesi : - 0,5 mm

Rundlaufgenauigkeit : 6µm  
Concentricity : 6µm  
Concentricité : 6µm  
Konsantriklik : 6µm

Komplettsatz : Seite 9.22  
Complete set : Page 9.22  
Kit complet : Voir page 9.22  
Komple set : Sayfa 9.22



## Collets DIN 6388 B

## Pinces de serrage DIN 6388, forme B

## Pensler DIN 6388 B Formu

Bestell-Nr. Order Nr. Référence Sipariş Nr.	d	D	L	Euro
467 E-04	4	43,7	60	
467 E-05	5	43,7	60	
467 E-06	6	43,7	60	
467 E-07	7	43,7	60	
467 E-08	8	43,7	60	
467 E-09	9	43,7	60	
467 E-10	10	43,7	60	
467 E-11	11	43,7	60	
467 E-12	12	43,7	60	
467 E-13	13	43,7	60	
467 E-14	14	43,7	60	
467 E-15	15	43,7	60	
467 E-16	16	43,7	60	
467 E-17	17	43,7	60	
467 E-18	18	43,7	60	
467 E-19	19	43,7	60	
467 E-20	20	43,7	60	
467 E-21	21	43,7	60	
467 E-22	22	43,7	60	
467 E-23	23	43,7	60	
467 E-24	24	43,7	60	
467 E-25	25	43,7	60	
467 E-26	26	43,7	60	
467 E-27	27	43,7	60	
467 E-28	28	43,7	60	
467 E-29	29	43,7	60	
467 E-30	30	43,7	60	
467 E-31	31	43,7	60	
467 E-32	32	43,7	60	

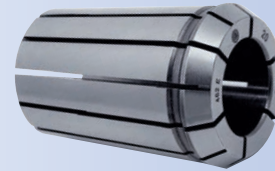
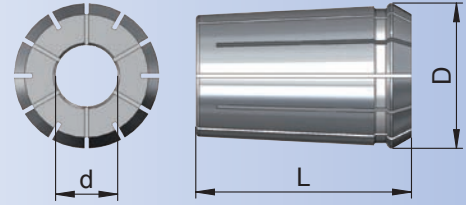

Spanntoleranz : - 0,5 mm

Clamping capacity : - 0,5 mm

Capacité de serrage : - 0,5 mm

Sıkma kapasitesi : - 0,5 mm

Rundlaufgenauigkeit : 10µm

Concentricity : 10µm

Concentricité : 10µm

Konsantrikliik : 10µm

Komplettsatz : Seite 9.22

Complete set : Page 9.22

Kit complet : Voir page 9.22

Komple set : Sayfa 9.22



## Collets System ER DIN 6499 B

## Pinces de serrage System ER DIN 6499, Forme B

## Pensler ER DIN 6499 B Formu

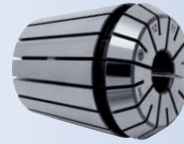
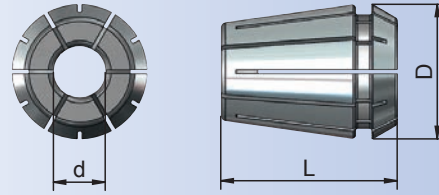

Bestell-Nr. Order Nr. Référence Sipariş Nr.	d	D	L	Euro
4004 E-01	1	8,5	13,6	
4004 E-1.5	1,5	8,5	13,6	
4004 E-02	2	8,5	13,6	
4004 E-02.5	2,5	8,5	13,6	
4004 E-03	3	8,5	13,6	
4004 E-03.5	3,5	8,5	13,6	
4004 E-04	4	8,5	13,6	
4004 E-04.5	4,5	8,5	13,6	
4004 E-05	5	8,5	13,6	

Spanntoleranz : - 0,5 mm  
Clamping capacity : - 0,5 mm  
Capacité de serrage : - 0,5 mm  
Sıkma kapasitesi : - 0,5 mm

Rundlaufgenauigkeit : 10µm  
Concentricity : 10µm  
Concentricité : 10µm  
Konsantriklik : 10µm

Komplettsatz : Seite 9.22  
Complete set : Page 9.22  
Kit complet : Voir page 9.22  
Komple set : Sayfa 9.22

## Spannzangen System ER DIN 6499 / ISO 15488-B

## ER 11 - B

## Collets System ER DIN 6499 B

## Pinces de serrage System ER DIN 6499, Forme B

## Pensler DIN 6499 B Formu

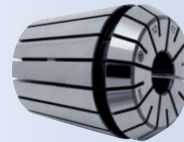
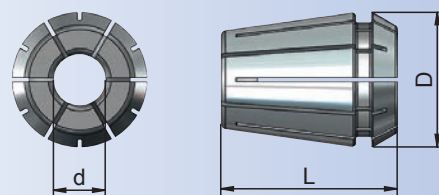

Bestell-Nr. Order Nr. Référence Sipariş Nr.	d	D	L	Euro
4008 E-01	1	11,5	0,8	
4008 E-1.5	1,5	11,5	18	
4008 E-02	2	11,5	0,8	
4008 E-02.5	2,5	11,5	18	
4008 E-03	3	11,5	0,8	
4008 E-03.5	3,5	11,5	18	
4008 E-04	4	11,5	0,8	
4008 E-04.5	4,5	11,5	0,8	
4008 E-05	5	11,5	18	
4008 E-05.5	5,5	11,5	0,8	
4008 E-06	6	11,5	18	
4008 E-06.5	6,5	11,5	0,8	
4008 E-07	7	11,5	18	

Spanntoleranz : - 0,5 mm  
Clamping capacity : - 0,5 mm  
Capacité de serrage : - 0,5 mm  
Sıkma kapasitesi : - 0,5 mm

Rundlaufgenauigkeit : 5µm  
Concentricity : 5µm  
Concentricité : 5µm  
Konsantriklik : 5µm

Komplettsatz : Seite 9.22  
Complete set : Page 9.22  
Kit complet : Voir page 9.22  
Komple set : Sayfa 9.22



**Collets System ER DIN 6499 B**

**Pinces de serrage System ER DIN 6499, Forme B**

**Pensler ER DIN 6499 B Formu**

Bestell-Nr. Order Nr. Référence Sipariş Nr.	d	D	L	Euro
426 E-01	1	17	27,5	
426 E-02	2	17	27,5	
426 E-03	3	17	27,5	
426 E-04	4	17	27,5	
426 E-05	5	17	27,5	
426 E-06	6	17	27,5	
426 E-07	7	17	27,5	
426 E-08	8	17	27,5	
426 E-09	9	17	27,5	
426 E-10	10	17	27,5	

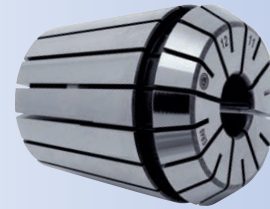
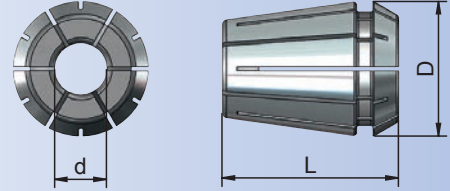

Spanntoleranz : Ø1-Ø2 (-0,5 mm) / Ø3-Ø10 (-1 mm)  
Clamping capacity : Ø1-Ø2 (-0,5 mm) / Ø3-Ø10 (-1 mm)  
Capacité de serrage : Ø1-Ø2 (-0,5 mm) / Ø3-Ø10 (-1 mm)  
Sıkma kapasitesi : Ø1-Ø2 (-0,5 mm) / Ø3-Ø10 (-1 mm)

Rundlaufgenauigkeit : 5µm  
Concentricity : 5µm  
Concentricité : 5µm  
Konsantriklik : 5µm

Komplettsatz : Seite 9.22  
Complete set : Page 9.22  
Kit complet : Voir page 9.22  
Komple set : Sayfa 9.22



## Collets System ER DIN 6499 B

## Pinces de serrage System ER DIN 6499, Forme B

## Pensler ER DIN 6499 B Formu

Bestell-Nr. Order Nr. Référence Sipariş Nr.	d	D	L	Euro
428 E-02	2	21	31,5	
428 E-03	3	21	31,5	
428 E-04	4	21	31,5	
428 E-05	5	21	31,5	
428 E-06	6	21	31,5	
428 E-07	7	21	31,5	
428 E-08	8	21	31,5	
428 E-09	9	21	31,5	
428 E-10	10	21	31,5	
428 E-11	11	21	31,5	
428 E-12	12	21	31,5	
428 E-13	13	21	31,5	

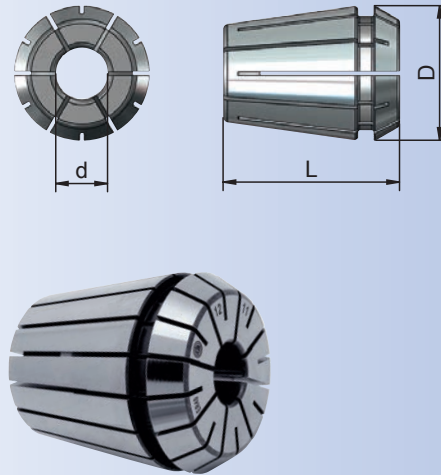

Spanntoleranz : Ø1-Ø2 (-0,5 mm) / Ø3-Ø13 (-1 mm)  
 Clamping capacity : Ø1-Ø2 (-0,5 mm) / Ø3-Ø13 (-1 mm)  
 Capacité de serrage : Ø1-Ø2 (-0,5 mm) / Ø3-Ø13 (-1 mm)  
 Sıkma kapasitesi : Ø1-Ø2 (-0,5 mm) / Ø3-Ø13 (-1 mm)

Rundlaufgenauigkeit : 5µm  
 Concentricity : 5µm  
 Concentricité : 5µm  
 Konsantriklik : 5µm

Komplettsatz : Seite 9.22  
 Complete set : Page 9.22  
 Kit complet : Voir page 9.22  
 Komple set : Sayfa 9.22



**Collets System ER DIN 6499 B**

**Pinces de serrage System ER DIN 6499, Forme B**

**Pensler ER DIN 6499 B Formu**

Bestell-Nr. Order Nr. Référence Sipariş Nr.	d	D	L	Euro
430 E-02	2	26	34	
430 E-03	3	26	34	
430 E-04	4	26	34	
430 E-05	5	26	34	
430 E-06	6	26	34	
430 E-07	7	26	34	
430 E-08	8	26	34	
430 E-09	9	26	34	
430 E-10	10	26	34	
430 E-11	11	26	34	
430 E-12	12	26	34	
430 E-13	13	26	34	
430 E-14	14	26	34	
430 E-15	15	26	34	
430 E-16	16	26	34	

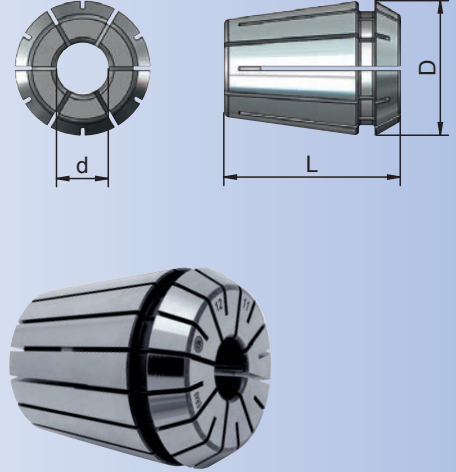

Spanntoleranz : Ø1-Ø2 (-0,5 mm) / Ø3-Ø16 (-1 mm)  
Clamping capacity : Ø1-Ø2 (-0,5 mm) / Ø3-Ø16 (-1 mm)  
Capacité de serrage : Ø1-Ø2 (-0,5 mm) / Ø3-Ø16 (-1 mm)  
Sıkma kapasitesi : Ø1-Ø2 (-0,5 mm) / Ø3-Ø16 (-1 mm)

Rundlaufgenauigkeit : 5µm  
Concentricity : 5µm  
Concentricité : 5µm  
Konsantriklik : 5µm

Komplettsatz : Seite 9.22  
Complete set : Page 9.22  
Kit complet : Voir page 9.22  
Komple set : Sayfa 9.22





## Collets System ER DIN 6499 B

## Pinces de serrage System ER DIN 6499, Forme B

## Pensler ER DIN 6499 B Formu

Bestell-Nr. Order Nr. Référence Sipariş Nr.	d	D	L	Euro
470 E-02	2	33	40	
470 E-03	3	33	40	
470 E-04	4	33	40	
470 E-05	5	33	40	
470 E-06	6	33	40	
470 E-07	7	33	40	
470 E-08	8	33	40	
470 E-09	9	33	40	
470 E-10	10	33	40	
470 E-11	11	33	40	
470 E-12	12	33	40	
470 E-13	13	33	40	
470 E-14	14	33	40	
470 E-15	15	33	40	
470 E-16	16	33	40	
470 E-17	17	33	40	
470 E-18	18	33	40	
470 E-19	19	33	40	
470 E-20	20	33	40	

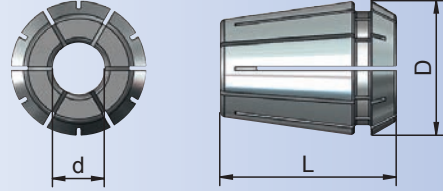

Spanntoleranz : -1 mm  
Clamping capacity : -1 mm  
Capacité de serrage : -1 mm  
Sıkma kapasitesi : -1 mm

Rundlaufgenauigkeit : 5µm  
Concentricity : 5µm  
Concentricité : 5µm  
Konsantriklik : 5µm

Komplettsatz : Seite 9.22  
Complete set : Page 9.22  
Kit complet : Voir page 9.22  
Komple set : Sayfa 9.22



Collets System ER DIN 6499 B

Pinces de serrage System ER DIN 6499, Forme B

Pensler ER DIN 6499 B Formu

Bestell-Nr. Order Nr. Référéncé Sipariş Nr.	d	D	L	Euro
472 E-03	3	41	46	
472 E-04	4	41	46	
472 E-05	5	41	46	
472 E-06	6	41	46	
472 E-07	7	41	46	
472 E-08	8	41	46	
472 E-09	9	41	46	
472 E-10	10	41	46	
472 E-11	11	41	46	
472 E-12	12	41	46	
472 E-13	13	41	46	
472 E-14	14	41	46	
472 E-15	15	41	46	
472 E-16	16	41	46	
472 E-17	17	41	46	
472 E-18	18	41	46	
472 E-19	19	41	46	
472 E-20	20	41	46	
472 E-21	21	41	46	
472 E-22	22	41	46	
472 E-23	23	41	46	
472 E-24	24	41	46	
472 E-25	25	41	46	
472 E-26	26	41	46	

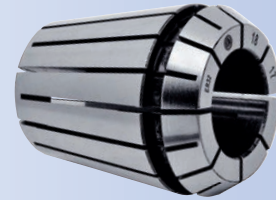
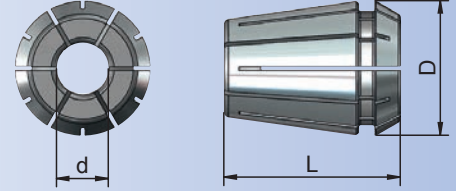

Spanntoleranz : -1 mm      Rundlaufgenauigkeit : 5µm  
Clamping capacity : -1 mm      Concentricity : 5µm  
Capacité de serrage : -1 mm      Concentricité : 5µm  
Sikma kapasitesi : -1 mm      Konsantriklik : 5µm

Komplettsatz : Seite 9.22  
Complete set : Page 9.22  
Kit complet : Voir page 9.22  
Komple set : Sayfa 9.22

Bestell-Nr. Order Nr. Référence Sipariş Nr.	Spannbereich Capacity Capacité Kapasite	d	D	 Vkt	L	Euro
ERGBD.10.3527	ER16	3,5	16,7	2,7	27,5	
ERGBD.10.0432	ER16	4	16,7	3,2	27,5	
ERGBD.10.4535	ER16	4,5	16,7	3,55	27,5	
ERGBD.10.0605	ER16	6	16,7	5	27,5	
ERGBD.10.0756	ER16	7	16,7	5,6	27,5	
ERGBD.10.0863	ER16	8	16,7	6,3	27,5	

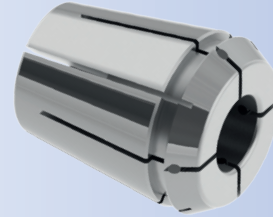
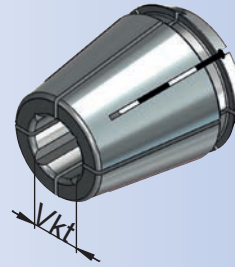
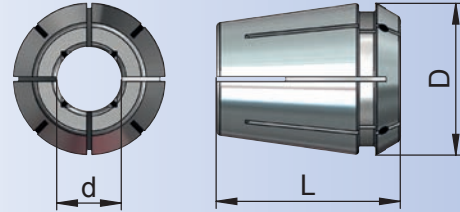

<b>new</b>	ERGBD.13.3527	ER20	3,5	20,7	2,7	31,5	
<b>new</b>	ERGBD.13.0432	ER20	4	20,7	3,2	31,5	
<b>new</b>	ERGBD.13.4535	ER20	4,5	20,7	3,55	31,5	
<b>new</b>	ERGBD.13.0605	ER20	6	20,7	5	31,5	
<b>new</b>	ERGBD.13.0756	ER20	7	20,7	5,6	31,5	
<b>new</b>	ERGBD.13.0863	ER20	8	20,7	6,3	31,5	
<b>new</b>	ERGBD.13.1008	ER20	10	20,7	8	31,5	
<b>new</b>	ERGBD.13.1109	ER20	11	20,7	9	31,5	
<b>new</b>	ERGBD.13.1209	ER20	12	20,7	9	31,5	

ERGBD.16.3527	ER25	3,5	25,7	2,7	34	
ERGBD.16.0432	ER25	4	25,7	3,2	34	
ERGBD.16.4535	ER25	4,5	25,7	3,55	34	
ERGBD.16.0605	ER25	6	25,7	5	34	
ERGBD.16.0756	ER25	7	25,7	5,6	34	
ERGBD.16.0863	ER25	8	25,7	6,3	34	
ERGBD.16.0971	ER25	9	25,7	7,1	34	
ERGBD.16.1008	ER25	10	25,7	8	34	
ERGBD.16.1109	ER25	11	25,7	9	34	
ERGBD.16.1209	ER25	12	25,7	9	34	
ERGBD.16.14112	ER25	14	25,7	11,2	34	
ERGBD.16.16125	ER25	16	25,7	12,5	34	

Spanntoleranz : h8  
Clamping capacity : h8  
Capacité de serrage : h8  
Sıkma kapasitesi : h8

Rundlaufgenauigkeit : 10µm  
Concentricity : 10µm  
Concentricité : 10µm  
Konsantriklik : 10µm



Collet system ER DIN 6499 A with square locking drive without length-adjustment

Pinces System ER DIN 6499 avec carré d'entraînement, Forme A

Kilavuz pensi için soğutmalı sistemler için keçeli tip, ER DIN 6499 A Formu

Bestell-Nr. Order Nr. Référence Sipariş Nr.	Spannbereich Capacity Capacité Kapasite	d	D	Vkt	L	Euro
ERGBD.20.0432	ER32	4	32,7	3,2	40	
ERGBD.20.4535	ER32	4,5	32,7	3,55	40	
ERGBD.20.0605	ER32	6	32,7	5	40	
ERGBD.20.0756	ER32	7	32,7	5,6	40	
ERGBD.20.0863	ER32	8	32,7	6,3	40	
ERGBD.20.0971	ER32	9	32,7	7,1	40	
ERGBD.20.1008	ER32	10	32,7	8	40	
ERGBD.20.1109	ER32	11	32,7	9	40	
ERGBD.20.1209	ER32	12	32,7	9	40	
ERGBD.20.14112	ER32	14	32,7	11,2	40	
ERGBD.20.16125	ER32	16	32,7	12,5	40	
ERGBD.20.18145	ER32	18	32,7	14,5	40	
ERGBD.20.2016	ER32	20	32,7	16	40	

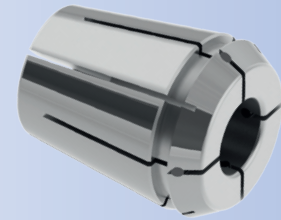
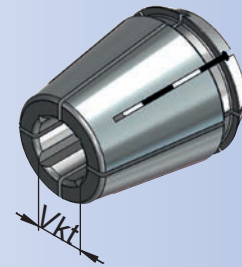
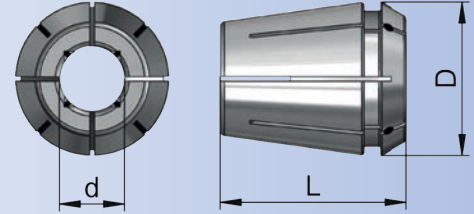

ERGBD.26.0605	ER40	6	40,7	5	46	
ERGBD.26.0756	ER40	7	40,7	5,6	46	
ERGBD.26.0863	ER40	8	40,7	6,3	46	
ERGBD.26.0971	ER40	9	40,7	7,1	46	
ERGBD.26.1008	ER40	10	40,7	8	46	
ERGBD.26.1109	ER40	11	40,7	9	46	
ERGBD.26.1209	ER40	12	40,7	9	46	
ERGBD.26.14112	ER40	14	40,7	11,2	46	
ERGBD.26.16125	ER40	16	40,7	12,5	46	
ERGBD.26.18145	ER40	18	40,7	14,5	46	
ERGBD.26.2016	ER40	20	40,7	16	46	
ERGBD.26.2218	ER40	22	40,7	18	46	
ERGBD.26.2520	ER40	25	40,7	20	46	

Spanntoleranz : h8  
Clamping capacity : h8  
Capacité de serrage : h8  
Sıkma kapasitesi : h8

Rundlaufgenauigkeit : 10µm  
Concentricity : 10µm  
Concentricité : 10µm  
Konsantriklik : 10µm

## Spannzangen für Präzisionskraftspannfutter



Collet for precision milling chuck

Pinces pour mandrin de fraisage de précision

Bilyalı pns tutucu için pens

Bestell-Nr. Order Nr. Référence Sipariş Nr.	d	D	L	Euro
EKS 20-06	6	20	53	
EKS 20-08	8	20	53	
EKS 20-10	10	20	53	
EKS 20-12	12	20	53	
EKS 20-16	16	20	53	
EKS 32-06	6	32	65	
EKS 32-08	8	32	65	
EKS 32-10	10	32	65	
EKS 32-12	12	32	65	
EKS 32-16	16	32	65	
EKS 32-20	20	32	65	
EKS 32-25	25	32	65	

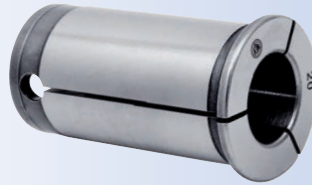
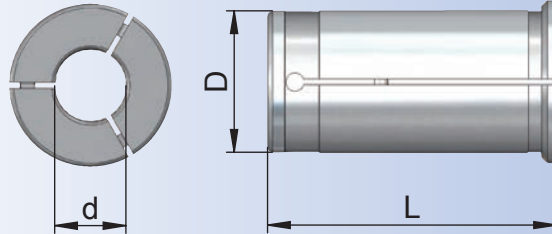

Komplettsatz : Seite 9.22  
Complete set : Page 9.22  
Kit complet : Voir page 9.22  
Komple set : Sayfa 9.22



## Reduzierungen für Hyrodehnspannfutter

Reducing arbor for hydraulic expansions chuck

Douille de réduction pour mandrins expansibles hydrauliques

Hidrolik takım tutucu pensi

Bestell-Nr. Order Nr. Référence Sipariş Nr.	d	D	L	Euro
R12-030	3	12	46	
R12-040	4	12	46	
R12-050	5	12	46	
R12-060	6	12	46	
R12-080	8	12	46	

R20-030	3	20	52,5	
R20-040	4	20	52,5	
R20-050	5	20	52,5	
R20-060	6	20	52,5	
R20-080	8	20	52,5	
R20-100	10	20	52,5	
R20-120	12	20	52,5	
R20-140	14	20	52,5	
R20-160	16	20	52,5	

R32-060	6	32	63	
R32-080	8	32	63	
R32-100	10	32	63	
R32-120	12	32	63	
R32-140	14	32	63	
R32-160	16	32	63	
R32-200	20	32	63	
R32-250	25	32	63	

Komplettsatz : Seite 9.22  
Complete set : Page 9.22  
Kit complet : Voir page 9.22  
Komple set : Sayfa 9.22

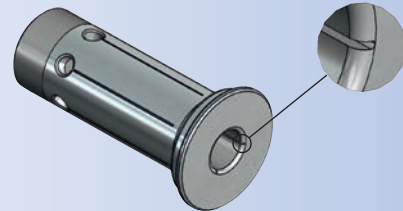
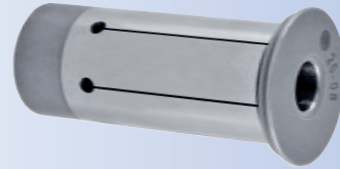
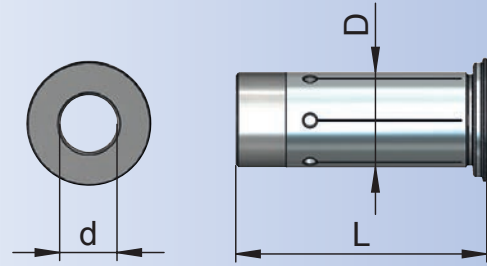

Kühlkanal-Bohrungen: Können als option bestellt werden  
(Beispiel Bestellnummer: R12-080.KKB)

Coolant Channels: Can be ordered as option  
(Example order code no: R12-080.KKB)

Conduits pour arrosage: Peuvent être commandés comme l'option  
(Exemple commande no: R12-080.KKB)

Soğutma kanalı: İsteğe bağlı alından su vermeli yapılabilir  
(Örnek sipariş no : R12-080.KKB)

## Reduzierungen für Hyrodehnspannfutter



### Reducing arbor for hydraulic expansions chuck

### Douille de réduction pour mandrins expansibles hydrauliques

### Hidrolik takım tutucu pensi

	Bestell-Nr. Order Nr. Référence Sipariş Nr.	d	D	L	Euro
new	R20-0.1875IN	3/16"	20	52,5	
new	R20-0.25IN	1/14"	20	52,5	
new	R20-0.3125IN	5/16"	20	52,5	
new	R20-0.375IN	3/8"	20	52,5	
new	R20-0.4375IN	7/16"	20	52,5	
new	R20-0.5IN	1/2"	20	52,5	
new	R20-0.5625IN	9/16"	20	52,5	
new	R20-0.625IN	5/8"	20	52,5	
new	R32-0.5IN	1/2"	32	63	
new	R32-0.5625IN	9/16"	32	63	
new	R32-0.625IN	5/8"	32	63	
new	R32-0.6875IN	11/16"	32	63	
new	R32-0.75IN	3/4"	32	63	
new	R32-0.875IN	7/8"	32	63	
new	R32-1.0IN	1"	32	63	

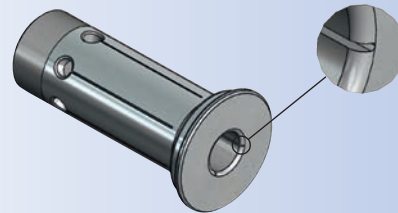
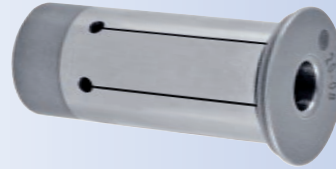
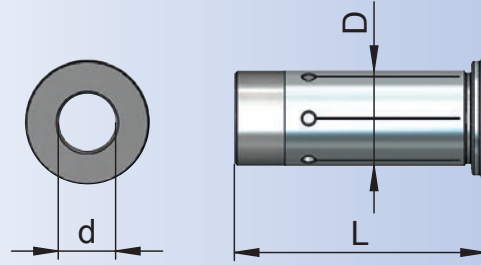

Kühlkanal-Bohrungen: Können als option bestellt werden  
(Beispiel Bestellnummer: R20-0.1875IN.KKB)

Coolant Channels: Can be ordered as option  
(Example order code no: R20-0.1875IN.KKB)

Conduits pour arrosage: Peuvent être commandés comme l'option  
(Exemple commande no: R20-0.1875IN.KKBB)

Soğutma kanalı: İsteğe bağlı alından su vermeli yapılabilir  
(Örnek sipariş no : R20-0.1875IN.KKB)



## Spannzangensatz im Koffer

Collet set in box

Set de pinces dans valise

Pens takımı plastik kutusu ile birlikte



Bestell-Nr. Order Nr. Référence Sipariş Nr.	Stück Piece Pièce Adet	Koffer Case Plastic Valise de plastique Plastik Kutu	Abmessung Size Dimension Cinsi	Euro
415 E-S	OZ16 (15 St.)	701.16.1	2-3-4-5-6-7-8-9-10-11-12-13-14-15-16	
462 E-S	OZ25 (16 St.)	701.25.1	4-5-6-7-8-9-10-11-12-14-16-18-20-22-24-25	
467 E-S	OZ32 (16 St.)	701.32.1	5-6-7-8-10-12-14-16-18-20-22-24-25-28-30-32	

*4004 E-S	4004 E (ER8) (9 St.)	701.05.1	1-1,5-2-2,5-3-3,5-4-4,5-5	
*4008 E-S	4008 E (ER11) (13 St.)	701.07.1	1 -1,5-2-2,5-3-3,5-4-4,5-5-5,5-6-6,5-7	
*426 E-S	426 E (ER16) (10 St.)	701.10.1	1-2-3-4-5-6-7-8-9-10	
*428 E-S	428 E (ER20) (12 St.)	701.13.1	2-3-4-5-6-7-8-9-10-11-12-13	
430 E-S	430 E (ER25) (15 St.)	701.16.1	2-3-4-5-6-7-8-9-10-11-12-13-14-15-16	
470 E-S	470 E (ER32) (18 St.)	701.20.1	3-4-5-6-7-8-9-10-11-12-13-14-15-16-17-18-19-20	
472 E-S	472 E (ER40) (23 St.)	701.26.1	4-5-6-7-8-9-10-11-12-13-14-15-16-17-18-19-20-21 -22-23-24-25-26	



Bestell-Nr. Order Nr. Référence Sipariş Nr.	Stück Piece Pièce Adet	Koffer Case Plastic Valise de plastique Plastik Kutu	Abmessung Size Dimension Cinsi	Euro
--	---------------------------------	---	---	------

new

EKS 20-S EKS 20 (5 St.) 701.20.2 6-8-10-12-16

new

EKS 32-S EKS 32 (7 St.) 701.32.2 6-8-10-12-16-20-25

new

\* R12-S R12 (5 St.) 701.12.1 3-4-5-6-8

new

\* R20-S R20 (9 St.) 701.30.2 3-4-5-6-8-10-12-14-16

new

\* R32-S R32 (8St.) 701.32.2 6-8-10-12-14-16-20-25



## Koffer



### Case Plastic

### Valise de Plastique

### Plastik Kutu

Bestell-Nr. Order Nr. Référence Sipariş Nr.	Abmessung Size Dimension Cinsi	Bohrungen Holes Trous taraudés Delik Sayısı	B x H x L	Euro
* 701.05.1	ER8	9	90 x 30 x 95	
* 701.07.1	ER11	13	90 x 30 x 95	
* 701.10.1	ER16	10	110 x 45 x 115	
<b>new</b> * 701.12.1	R12	5	210 x 72 x 255	
* 701.13.1	ER20	12	110 x 45 x 115	
701.16.1	ER25-0Z16	15	185 x 48 x 235	
701.20.1	ER32	18	230 x 83 x 275	
<b>new</b> 701.20.2	R20-EKS20	9	210 x 72 x 255	
701.25.1	OZ25	16	210 x 72 x 255	
701.26.1	ER40	23	275 x 83 x 340	
701.32.1	OZ32	16	275 x 83 x 340	
<b>new</b> 701.32.2	R32-EKS32	8	210 x 72 x 255	



\*





## Spannmutter OZ DIN 6388 D kugelgelagerte Ausführung

Clamping nuts OZ DIN 6388 D ball-bearing version

Écrou de serrage DIN 6388 D version rolument à billes

Pens kapağı bilyeli tip DIN 6388 D

Bestell-Nr. Order Nr. Référence Sipariş Nr.	Abmessung Size Dimension Cinsi	D	Gewinde Tap Filet Diş	Euro
112.01.16	415 E	43	M33 x 1,5	
112.01.25	462 E	60	M48 x 2	
112.01.32	467 E	72	M 60 x 2,5	

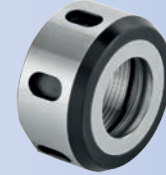
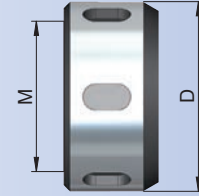

### Zubehör / Accessories / Accessoires / Yedekler



Hakenschlüssel DIN 1810 A  
Wrench DIN 1810 A  
Clé à ergot DIN 1810 A  
E tipi ay anahtar DIN 1810 A

## Spannmutter ER Mini

Clamping Nut ER Mini

Écrou ER Mini

ER Mini Kapak

Bestell-Nr. Order Nr. Référence Sipariş Nr.	Abmessung Size Dimension Cinsi	D	Gewinde Tap Filet Diş	Euro
109.02.05	ER8	12	M10x0,75	
109.02.07	ER11	16	M13x0,75	
109.02.10	ER16	22	M19 x 1	

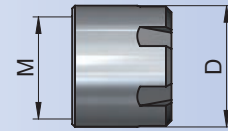

### Zubehör / Accessories / Accessoires / Yedekler



Spannschlüssel  
Wrench  
Clé de serrage  
ER tipi anahtar

9.24



## Spannmutter ER DIN 6499 Standardausführung mit Exzenterring - gewuchtet

Clamping nuts ER DIN 6499 - balanced

Écrou de serrage ER DIN 6499 version standard avec bague excentrique - équilibré

Pens kapağı ER tipi DIN 6499 Balansı alınmış

Bestell-Nr. Order Nr. Référence Sipariş Nr.	Abmessung Size Dimension Cinsi	D	Gewinde Tap Filet Diş	Euro
* 110.02.07.6KT	ER11	19 SW 17	M14 X 0,75	
* 110.02.10.6KT	ER16	28 SW 25	M22 x 1,5	
110.02.10	ER16	32	M22 X 1,5	
* 110.02.13.6KT	ER20	34 SW 30	M25 x 1,5	
110.02.16	ER25	42	M 32 x 1,5	
110.02.20	ER32	50	M40 x 1,5	
110.02.26	ER40	63	M50x 1,5	

- \* Sechskantmutter
- \* Six side clamping nuts
- \* Ecrou à 6 pens
- \* 6 köşeli

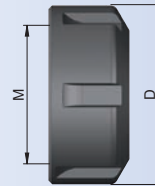
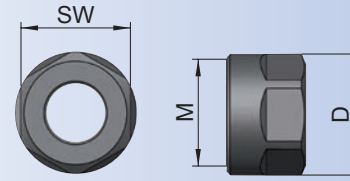

## Spannmutter ER DIN 6499 Kugelgelagerte Ausführung

Clamping nuts ER DIN 6499 Ball-bearing version

Écrou de serrage ER DIN 6499 version roulement à billes

Pens kapağı ER tipi DIN 6499 Bilyalı tip

Bestell-Nr. Order Nr. Référence Sipariş Nr.	Abmessung Size Dimension Cinsi	D	Gewinde Tap Filet Diş	Euro
* 112.02.10	ER16	30 SW 27	M22 x 1,5	
112.02.13	ER20	35	M25 x 1,5	
112.02.16	ER25	42	M32 x 1,5	
112.02.20	ER32	50	M40 x 1,5	
112.02.26	ER40	63	M50 x 1,5	

- \* Sechskantmutter
- \* Six side clamping nuts
- \* Ecrou à 6 pens
- \* 6 köşeli

Zubehör / Accessories / Accessoires / Yedekler



Spannschlüssel für ER  
Wrench ER  
Clé de serrage ER  
ER tipi anahtar

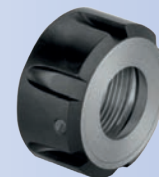
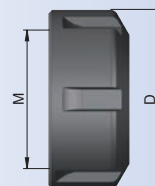
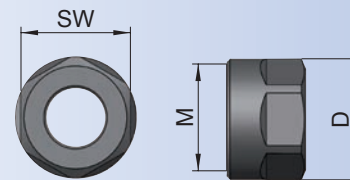

ZUBEHÖR  
ACCESSORIES



## Spannmutter OZ DIN 6388 D für Dichtscheiben

Clamping nuts OZ for sealing disc DIN 6388 D

Écrou de serrage OZ pour joints DIN 6388 D

Pens kapağı DIN 6388 D

Su sızdırmaz ringli içten soğutmalı takımlar için

Bestell-Nr. Order Nr. Référence Sipariş Nr.	Abmessung Size Dimension Cinsi	D	Gewinde Tap Filet Diş	Euro
113.01.16	415 E	43	M33 x 1,5	
113.01.25	462 E	60	M48 x 2	
113.01.32	467 E	72	M60 x 2,5	

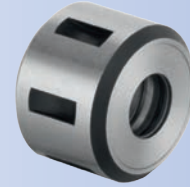
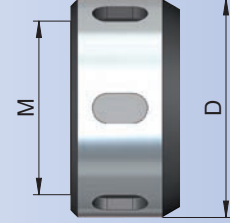

### Zubehör / Accessories / Accessoires / Yedekler



Hakenschlüssel DIN 1810 A  
Wrench DIN 1810 A  
Clé à ergot DIN 1810 A  
E tipi anahtar DIN 1810 A

## Spannmutter ER DIN 6499 für Dichtscheiben

Clamping nuts ER DIN 6499 for sealing disc

Écrou de serrage pour joints ER DIN 6499

Pens kapağı DIN 6499 ER tipi Su sızdırmaz ringli

Bestell-Nr. Order Nr. Référence Sipariş Nr.	Abmessung Size Dimension Cinsi	D	Gewinde Tap Filet Diş	Euro
* 113.02.10	ER16	28 SW 25	M22 x 1,5	
113.02.16	ER25	42	M32 X 1,5	
113.02.20	ER32	50	M40 x 1,5	
113.02.26	ER40	63	M50 x 1,5	

- \* Sechskantmutter
- \* Six side clamping nuts
- \* Ecrou á 6 pens
- \* 6 köşeli

### Zubehör / Accessories / Accessoires / Yedekler



Spannschlüssel für ER  
Wrench ER  
Clé de serrage ER  
ER tipi anahtar

9.26

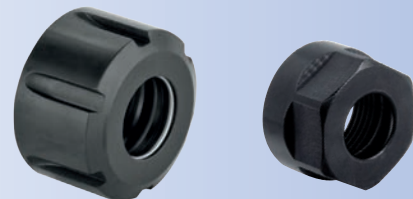
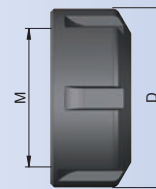
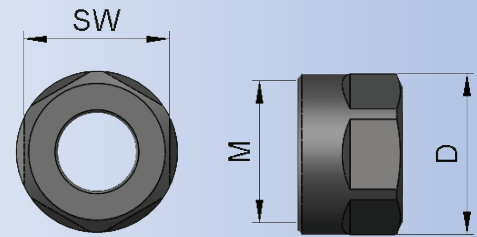



## Dichtscheiben für OZ Spannmuttern

Sealing disc for OZ clamping nuts

Joints écrou de serrage OZ

Su sızdırmaz ringi içten soğutmalı takımlar için

Bestell-Nr. Order Nr. Référence Sipariş Nr.	d je 0,5 mm	D	Typ	Euro
01.16.XXX	3,0-6,0	20,3	415 E	
	6,5-16,0			
01.25.XXX	3,0-6,0	29,8	462 E	
	6,5-25,0			
01.32. XXX	3,0-6,0	38,3	467 E	
	6,5-32,0			

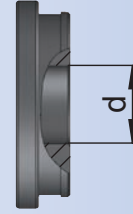

## Dichtscheiben für ER Spannmuttern

ER

Sealing Disc for ER clamping nuts

Joints pour écrou de serrage ER

Su sızdırmaz ringi içten soğutmalı takımlar için

Bestell-Nr. Order Nr. Référence Sipariş Nr.	d je 0,5 mm	D	Typ	Euro
02.10.xxx	3,0 - 6,0	12,85	ER 16	
	6,5-10,0			
02.16.xxx	3,0 - 6,0	20,80	ER 25	
	6,5-16,0			
02.20.xxx	3,0 - 6,0	26,80	ER 32	
	6,5 - 20,0			
02.26.xxx	3,0 - 6,0	33,30	ER 40	
	6,5 - 26,0			

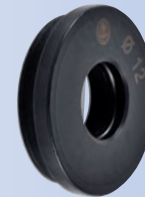
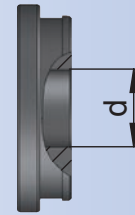



## Reduzierbüchse für Bohrstangenhalter

Reduction bushes for boring bar holder

Douille de réduction pour barre d'alésage

Delik kateri redüksiyonu

Bestell-Nr. Order Nr. Référence Sipariş Nr.	d	d1	L	L1	L2	a	Euro
709.25.06.45	25	6	45	5	35	10,5	
709.25.08.45	25	8	45	5	35	10,5	
709.25.10.45	25	10	45	5	35	10,5	
709.25.12.45	25	12	45	5	35	10,5	
709.25.14.45	25	14	45	5	35	10,5	
709.25.16.45	25	16	45	5	35	10,5	
<b>new</b> 709.25.18.45	25	18	45	5	35	10,5	
709.25.20.45	25	20	45	5	35	10,5	
709.32.06.65	32	6	65	5	45	10,5	
709.32.08.65	32	8	65	5	45	10,5	
709.32.10.65	32	10	65	5	45	10,5	
709.32.12.65	32	12	65	5	45	10,5	
709.32.14.65	32	14	65	5	45	10,5	
709.32.16.65	32	16	65	5	45	10,5	
<b>new</b> 709.32.18.65	32	18	65	5	45	10,5	
709.32.20.65	32	20	65	5	45	10,5	
709.32.25.65	32	25	65	5	45	10,5	
709.40.06.75	40	6	75	5	52	12,5	
709.40.08.75	40	8	75	5	52	12,5	
709.40.10.75	40	10	75	5	52	12,5	
709.40.12.75	40	12	75	5	52	12,5	
709.40.14.75	40	14	75	5	52	12,5	
709.40.16.75	40	16	75	5	52	12,5	
<b>new</b> 709.40.18.75	40	18	75	5	54	12,5	
709.40.20.75	40	20	75	5	54	12,5	
709.40.25.75	40	25	75	5	54	12,5	
709.40.32.75	40	32	75	5	54	12,5	

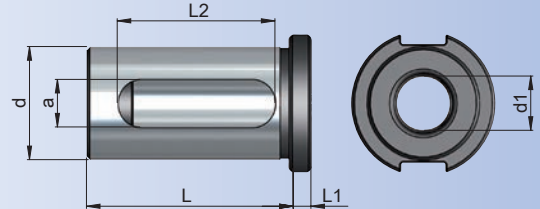

## Reduzierbüchse für Bohrstangenhalter



Reduction bushes for boring bar holder

Douille de réduction pour barre d'alésage

Delik kateri redüksiyonu

	Bestell-Nr. Order Nr. Référence Sipariş Nr.	d	d1	L	L1	Type	Euro
new	709.25.06.1.46	25	6	46	4	1	
new	709.25.08.1.46	25	8	46	4	1	
new	709.25.10.1.46	25	10	46	4	1	
new	709.25.12.1.46	25	12	46	4	1	
new	709.25.14.1.46	25	14	46	4	2	
new	709.25.16.1.46	25	16	46	4	2	
new	709.25.18.1.46	25	18	46	4	2	
new	709.25.20.1.46	25	20	46	4	2	
new	709.32.06.1.53	32	6	53	5	1	
new	709.32.08.1.53	32	8	53	5	1	
new	709.32.10.1.53	32	10	53	5	1	
new	709.32.12.1.53	32	12	53	5	1	
new	709.32.14.1.53	32	14	53	5	1	
new	709.32.16.1.53	32	16	53	5	2	
new	709.32.18.1.53	32	18	53	5	2	
new	709.32.20.1.53	32	20	53	5	2	
new	709.32.25.1.53	32	25	53	5	2	
new	709.40.06.1.53	40	6	53	5	1	
new	709.40.08.1.53	40	8	53	5	1	
new	709.40.10.1.53	40	10	53	5	1	
new	709.40.12.1.53	40	12	53	5	1	
new	709.40.14.1.53	40	14	53	5	1	
new	709.40.16.1.53	40	16	53	5	1	
new	709.40.18.1.53	40	18	53	5	1	
new	709.40.20.1.53	40	20	53	5	1	
new	709.40.25.1.53	40	25	53	5	2	
new	709.40.32.1.53	40	32	53	5	2	

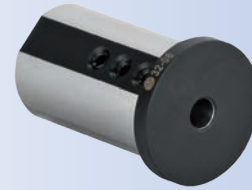
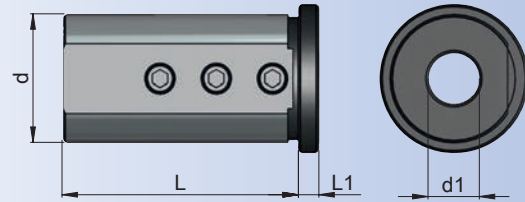

Type 1



Type 2



## Reduzierbüchse für Bohrstangenhalter

Reduction bushes for boring bar holder

Douille de réduction pour barre d'alésage

Delik kateri redüksiyonu

	Bestell-Nr. Order Nr. Référence Sipariş Nr.	d	d1	L	L1	Type	Euro
new	709.32.06.1.80	32	6	80	5	1	
new	709.32.08.1.80	32	8	80	5	1	
new	709.32.10.1.80	32	10	80	5	1	
new	709.32.12.1.80	32	12	80	5	1	
new	709.32.14.1.80	32	14	80	5	1	
new	709.32.16.1.80	32	16	80	5	2	
new	709.32.18.1.80	32	18	80	5	2	
new	709.32.20.1.80	32	20	80	5	2	
new	709.32.25.1.80	32	25	80	5	2	
new	709.40.06.1.80	40	6	80	5	1	
new	709.40.08.1.80	40	8	80	5	1	
new	709.40.10.1.80	40	10	80	5	1	
new	709.40.12.1.80	40	12	80	5	1	
new	709.40.14.1.80	40	14	80	5	1	
new	709.40.16.1.80	40	16	80	5	1	
new	709.40.18.1.80	40	18	80	5	1	
new	709.40.20.1.80	40	20	80	5	1	
new	709.40.25.1.80	40	25	80	5	2	
new	709.40.32.1.80	40	32	80	5	2	

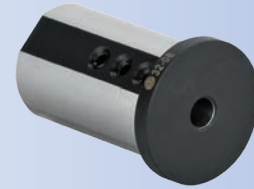
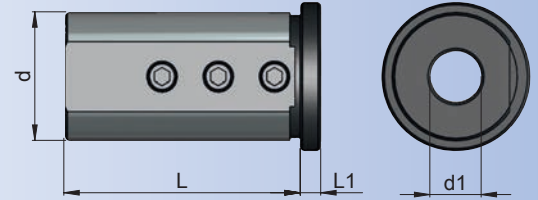

Type 1



Type 2





## Pull studs

## Tirettes

## Çektirme civataları

Bestell-Nr. Order Nr. Référence Sipariş Nr.	Abmessung Size Dimension Cinsi	D	M	I	L	d	d1	h	O - ring joint torique	
									X	Euro
401.20.16.S	S 20x2	S 20x2	M16	22	55	17	-	4	-	
*401.20.16.IK	M16	25	M16	28	53	21,1	7	13,7	-	
*501.20.24.IK	M24	39,2	M24	40	65	32	7	13	-	

\* Mit zusätzlichem Innengewinde

\* With internal screw thread

\* Avec Filet supplémentaire

\* İçten çekirme dişli

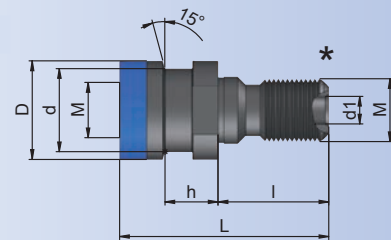
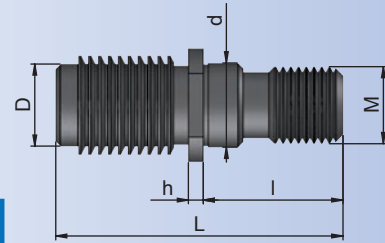

## Anzugsbolzen

## DIN 69872 - A / MAS 403 BT

## Pull studs

## Tirettes

## Çektirme civataları

Bestell-Nr. Order Nr. Référence Sipariş Nr.	Type	D	M	I	L	d	d1	h	O - ring joint torique	
									X	Euro
302.20.12	DIN 69872-A	13	M12	20	44	9	-	19		
<b>new</b> 302.20.12.1	DIN 69872-A	12	M12	20	44	8	-	19		
402.20.16.IK	DIN 69872-A	19	M16	28	54	14	7	20	X	
405.20.16.4.IK	BT OKUMA-MAKINO	19	M16	25	54	14	4	23	X	
405.20.16.7.IK	BT	19	M16	25	54	14	7	23	X	
403.20.16	DIN 69872-A	19	M16	28	54	14	-	20	X	
502.20.24.IK	DIN 69872-A	28	M24	40	74	21	11,5	25	X	
503.20.24	DIN 69872-A	28	M24	40	74	21	-	25	X	

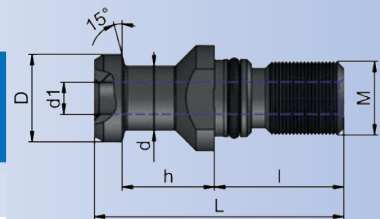

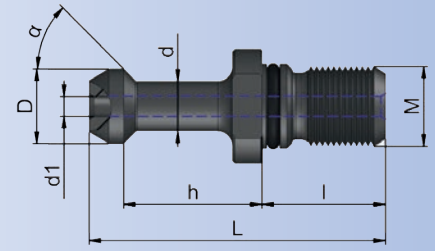
**Pull studs****Tirettes****Çektirme civataları**

Bestell-Nr. Order Nr. Référence Sipariş Nr.	D	M	$\alpha$	l	L	d	d1	h	O - ring joint torique X	Euro
305.20.45	11	M12	45°	20	43	7	-	18	-	
405.20.45	15	M16	45°	25	60	10	-	28	X	
505.20.45	23	M24	45°	40	85	17	-	35	X	
305.20.60	11	M12	60°	20	43	7	-	18	-	
405.20.60	15	M16	60°	25	60	10	-	28	X	
505.20.60	23	M24	60°	40	85	17	-	35	X	
305.20.90	11	M12	90°	20	43	7	-	18	-	
405.20.90	15	M16	90°	25	60	10	-	28	X	
505.20.90	23	M24	90°	40	85	17	-	35	X	
306.20.45.IK	11	M12	45°	20	43	8	2,5	18	X	
406.20.45.IK	15	M16	45°	25	60	10	3	28	X	
506.20.45.IK	23	M24	45°	40	85	17	6	35	X	
406.20.60.IK	15	M16	60°	25	60	10	3	28	X	
506.20.60.IK	23	M24	60°	40	85	17	6	35	X	
406.20.90.IK	15	M16	90°	25	60	10	3	28	X	
506.20.90.IK	23	M24	90°	40	85	17	6	35	X	
405.20.45.1	15	M16	45°	25	57	10	-	25	X	
406.20.45.1.IK	15	M16	45°	25	57	10	3	25	X	



Pull studs

Tirettes

Çektirme civataları

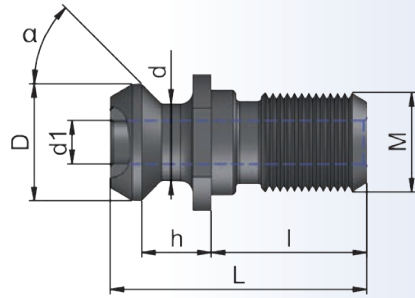

Bestell-Nr. Order Nr. Référence Sipariş Nr.	Type	D	M	$\alpha$	L	d	d1	l	h	O - ring joint torique X	Euro
404.20.16.IK	ISO 40	18,95	M16	45°	44,4	12,95	7,35	28	11,15	X	
504.20.24.IK	ISO 50	29,1	M24	45°	65,55	19,6	11,55	40	17,95	X	
407.20.16.IK	CAT 40 - MAZAK	18,796	M16	45°	41,256	12,446	7	25	11,176	-	
407.20.16.1.IK	BT 40-MAZAK	18,796	M16	45°	44,106	12,446	7	25	14,026	-	
507.20.24.IK	CAT 50 - MAZAK	28,956	M24	45°	65,4	20,828	10	40	17,78	-	
<b>new</b> 507.20.24.1.IK	BT 50 - MAZAK	28,956	M24	45°	65,2	20,828	10	40	17,58	-	



## Einsatz mit Rutschkupplung

M2 - M14

Tapping collets with clutch

Douille avec limiteur de couple

Kılavuz tutucu emniyetli

Bestell-Nr. Order Nr. Référence Sipariş Nr.	M	D	d	L1	Ø	□	Euro
16.11.M02.2821	M2	32	19	25	2,8	2,1	
16.11.M25.2821	M2,5	32	19	25	2,8	2,1	
16.11.M03.3527	M3	32	19	25	3,5	2,7	
16.11.M35.0403	M3,5	32	19	25	4	3	
16.11.M04.4534	M4	32	19	25	4,5	3,4	
<b>new</b> 16.11.M04.2821	M4	32	19	25	2,8	2,1	
16.11.M05.0649	M5	32	19	25	6	4,9	
16.11.M05.3527	M5	32	19	25	3,5	2,7	
<b>new</b> 16.11.M06.4534	M6	32	19	25	4,5	3,4	
<b>new</b> 16.11.M06.0649	M6	32	19	25	6	4,9	
16.11.M08.0862	M8	32	19	25	8	6,2	
<b>new</b> 16.11.M08.0649	M8	32	19	25	6	4,9	
16.11.M10.0755	M10	32	19	25	7	5,5	
16.11.M10.1008	M10	32	19	25	10	8	
16.11.M12.0907	M12	32	19	25	9	7	
16.11.M14.1109	M14	32	19	25	11	9	

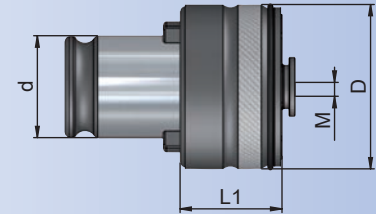

## Einsatz ohne Rutschkupplung

M2 - M14

Tapping collets without clutch

Douille sans limiteur de couple

Kılavuz tutucu emniyetsiz

Bestell-Nr. Order Nr. Référence Sipariş Nr.	M	D	d	L1	Ø	□	Euro
16.01.2821	M2 - M2,2 - M2,5 - M4	30	19	6	2,8	2,1	
16.01.3527	M3 - M5	30	19	6	3,5	2,7	
16.01.0403	M3,5	30	19	6	4	3	
16.01.4537	M4 - M6	30	19	6	4,5	3,4	
16.01.0649	M5 - M6 - M8	30	19	6	6	4,9	
16.01.0862	M8	30	19	6	8	6,2	
16.01.0755	M10	30	19	6	7	5,5	
16.01.1008	M10	30	19	6	10	8	
16.01.0907	M12	30	19	6	9	7	
16.01.1109	M14	30	19	6	11	9	

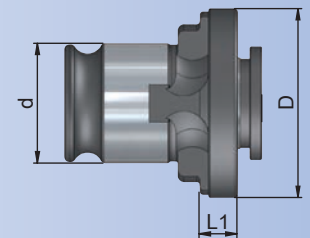



## Tapping collets with clutch

## Douille avec limiteur de couple

## Kılavuz tutucu emniyetli

Bestell-Nr. Order Nr. Référence Sipariş Nr.	M	D	d	L1	Ø	□	Euro
16.12.M05.0649	M5	50	31	31	6	4,9	
16.12.M06.0649	M6	50	31	31	6	4,9	
16.12.M08.0862	M8	50	31	31	8	6,2	
16.12.M08.0649	M8	50	31	31	6	4,9	
16.12.M10.0755	M10	50	31	31	7	5,5	
16.12.M10.1008	M10	50	31	31	10	8	
16.12.M12.0907	M12	50	31	31	9	7	
16.12.M14.1109	M14	50	31	31	11	9	
16.12.M16.1209	M16	50	31	31	12	9	
16.12.M18.1411	M18	50	31	31	14	11	
16.12.M20.1612	M20	50	31	31	16	12	
16.12.M22.18145	M22	50	31	31	18	14,5	
16.12.M24.18145	M24	50	31	31	18	14,5	

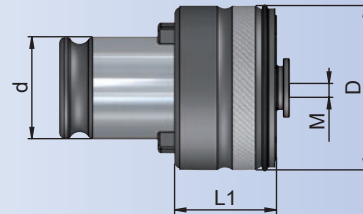

## Einsatz ohne Rutschkupplung

## M5 - M24

## Tapping collets without clutch

## Douille sans limiteur de couple

## Kılavuz tutucu emniyetsiz

Bestell-Nr. Order Nr. Référence Sipariş Nr.	M	D	d	L1	Ø	□	Euro
16.02.0649	M5 - M6 - M8	46,5	31	8,5	6	4,9	
16.02.0862	M8	46,5	31	8,5	8	6,2	
16.02.0755	M10	46,5	31	8,5	7	5,5	
16.02.1008	M10	46,5	31	8,5	10	8	
16.02.0907	M12	46,5	31	8,5	9	7	
16.02.1109	M14	46,5	31	8,5	11	9	
16.02.1209	M16	46,5	31	8,5	12	9	
16.02.1411	M18	46,5	31	8,5	14	11	
16.02.1612	M20	46,5	31	8,5	16	12	
16.02.18145	M22 - M24	46,5	31	8,5	18	14,5	

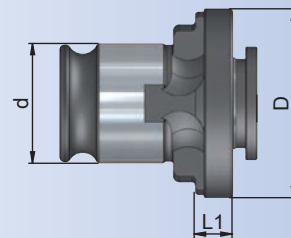



## Einsatz mit Rutschkupplung

M14 - M36

Tapping collets with clutch

Douille avec limiteur de couple

Kilavuz tutucu emniyetli

Bestell-Nr. Order Nr. Référence Sipariş Nr.	M	D	d	L1	Ø	□	Euro
16.13.M14.1109	M14	72	48	41	11	9	
16.13.M16.1209	M16	72	48	41	12	9	
16.13.M18.1411	M18	72	48	41	14	11	
16.13.M20.1612	M20	72	48	41	16	12	
16.13.M22.18145	M22	72	48	41	18	14,5	
16.13.M24.18145	M24	72	48	41	18	14,5	
16.13.M27.2016	M27	72	48	41	20	16	
16.13.M30.2218	M30	72	48	41	22	18	
16.13.M33.2520	M33	72	48	41	25	20	
16.13.M36.2822	M36	72	48	41	28	22	

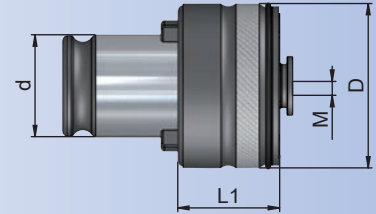

## Einsatz ohne Rutschkupplung

M14 - M36

Tapping collets without clutch

Douille sans limiteur de couple

Kilavuz tutucu emniyetsiz

Bestell-Nr. Order Nr. Référence Sipariş Nr.	M	D	d	L1	Ø	□	Euro
16.03.1109	M14	63	48	11	11	9	
16.03.1209	M16	63	48	11	12	9	
16.03.1411	M18	63	48	11	14	11	
16.03.1612	M20	63	48	11	16	12	
16.03.18145	M22 - M24	63	48	11	18	14,5	
16.03.2016	M27	63	48	11	20	16	
16.03.2218	M30	63	48	11	22	18	
16.03.2520	M33	63	48	11	25	20	
16.03.2822	M36	63	48	11	28	22	

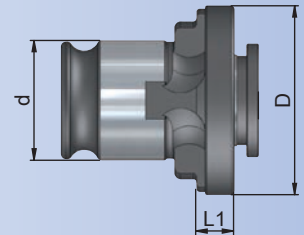

## Gewindebohrerhalter mit Zylinderschaft DIN 1835 B, ohne Rutschkupplung



Tap holder with cylindrical shank DIN 1835 B without clutch

Porte-taraud avec queue cylindrique DIN 1835 B sans limiterur de couple

Silindirik Şaftlı Kılavuz Tutucu emniyetsiz

Bestell-Nr. Order Nr. Référence Sipariş Nr.	M	D	L	d	□	Euro
16.16.3527.56	M3 - M5	16	56	3,5	2,7	
16.16.0403.56	M3,5	16	56	4	3	
16.16.4534.56	M4 - M6	16	56	4,5	3,4	
16.16.0649.56	M5 - M6 - M8	16	56	6	4,9	
16.20.4534.58	M4 - M6	20	58	4,5	3,4	
16.20.0649.58	M5 - M6 - M8	20	58	6	4,9	
16.20.0862.58	M8	20	58	8	6,2	
16.20.0755.58	M10	20	58	7	5,5	
16.20.1008.58	M10	20	58	10	8	
16.20.0907.58	M12	20	58	9	7	
16.25.4534.66	M4 - M6	25	66	4,5	3,4	
16.25.0649.66	M5 - M6 - M8	25	66	6	4,9	
16.25.0862.66	M8	25	66	8	6,2	
16.25.0755.66	M10	25	66	7	5,5	
16.25.1008.66	M10	25	66	10	8	
16.25.0907.66	M12	25	66	9	7	
16.25.1109.66	M14	25	66	11	9	
16.25.1209.66	M16	25	66	12	9	
16.32.0649.70	M5 - M6 - M8	32	70	6	4,9	
16.32.0862.70	M8	32	70	8	6,2	
16.32.0755.70	M10	32	70	7	5,5	
16.32.1008.70	M10	32	70	10	8	
16.32.0907.70	M12	32	70	9	7	
16.32.1109.70	M14	32	70	11	9	
16.32.1209.70	M16	32	70	12	9	
16.32.1411.70	M18	32	70	14	11	
16.32.1612.70	M20	32	70	16	12	
16.32.18145.70	M22 - M24	32	70	18	14,5	

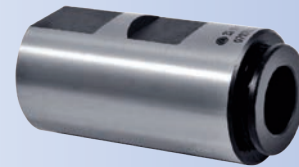
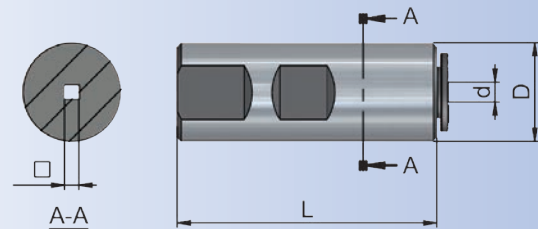



## Spannschraube für Weldon Spannfutter DIN 1835 B

Clamping screw weldon DIN 1835 B

Vis de serrage weldon DIN 1835 B

Veldon sıkma civatası DIN 1835 B

Bestell-Nr. Order Nr. Référéncé Sipariş Nr.	Abmessung Size Dimension Cinsi	DIN 1835 M	L	Veldon Ø	Euro
160.M06.100.010	-	M6	10	6	
160.M08.125.010	-	M8	10	8	
160.M10.150.012	-	M10	12	10	
160.M12.175.016	-	M12	16	12-14	
160.M14.200.016	-	M14	16	16-18	
160.M16.200.020	-	M16	16	20	
160.M18.200.020	-	M18x2	20	25	
160.M20.200.020	-	M20x2	20	32-40	

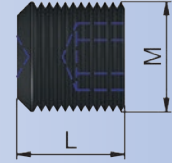

160.M14.200.016	402.04.16.0	M14	16	16	
	405.04.16.0				
160.M16.200.014	405.04.20.0	M16	14	20	
160.M16.200.016	402.04.20.0	M16	16	20	

Bestell-Nr. Order Nr. Référéncé Sipariş Nr.	Abmessung Size Dimension Cinsi	DIN 913 M	L	Veldon Ø	Euro
161.M16.100.008	402.04.25.0	M16x1	8	25	
	405.04.25.0				
161.M16.100.012	402.04.25.0	M16x1	12	25	
	405.04.25.0				
161.M16.100.008	402.04.32.0	M16x1	8	32	
	405.04.32.0	M16x1			
161.M16.100.010	402.04.32.0	M16x1	10	32	
161.M16.100.014	405.04.32.0	M16x1	14	32	

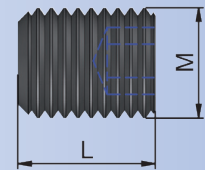





## Spanschraube

Clamping screw

Vis de serrage

Sıkma civatası

Bestell-Nr. Order Nr. Référence Sipariş Nr.	DIN 913 M	DIN 914 M	L	Form E1 d2	Euro
161.M10.100.012	M10x1	–	12	Ø16 - Ø20	
*162.M10.100.014	–	M10x1	14	Ø16 - Ø20	
161.M12.100.012	M12x1	–	12	Ø25 - Ø32	
*162.M12.100.014	–	M12x1	14	Ø25 - Ø32	
161.M16.100.012	M16x1	–	12	Ø40 - Ø50	
*162.M16.100.014	–	M16x1	14	Ø40 - Ø50	

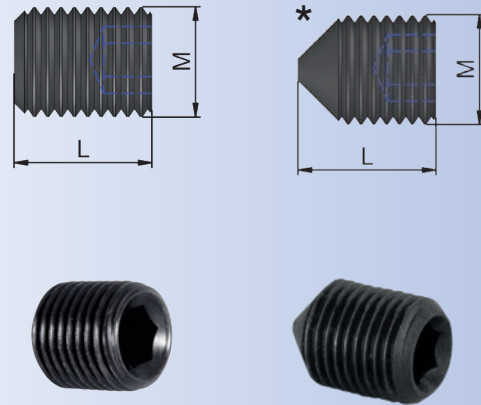

## Einstellschraube

Adjustment screw

Vis de réglage

Ayar civatası

Bestell-Nr. Order Nr. Référence Sipariş Nr.	DIN 915 M	L	ARF-Plus	Euro
<b>new</b> 166.M06.100.012	M6	12	SK-BT-HSK-EPS	
<b>new</b> 166.M06.100.020	M6	20	SK-BT-HSK-EPS	

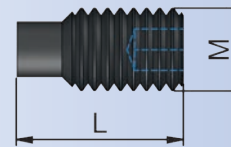

## Anzugsschraube

Bolt

Tirette

Civata

Bestell-Nr. Order Nr. Référence Sipariş Nr.	DIN 912 M	L	ARF-Plus	Euro
<b>new</b> 163.M06.100.020	M6	20	SK-BT-HSK-EPS	

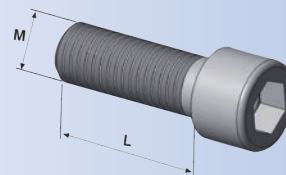



## Spannschraube

Clamping screw

Vis de serrage

Sıkma civatası

Bestell-Nr. Order Nr. Référence Sipariş Nr.	DIN 913 M	L	Form E2 d1xd2	Euro
161.M06.100.012	M6	12	16x06 16x08	
161.M06.100.010	M6	10	16x10	
161.M08.125.012	M8	12	16x12	
161.M08.125.010	M8	10	16x16	
161.M06.100.016	M6	16	20x08	
161.M06.100.014	M6	14	20x10	
161.M08.125.014	M8	14	20x12	
161.M08.125.012	M8	12	20x16 20x20	
161.M08.125.010	M8	10	20x25	
161.M06.100.016	M6	16	25x08	
161.M06.100.014	M6	14	25x10	
161.M08.125.014	M8	14	25x12	
161.M08.125.012	M8	12	25x16	
161.M08.125.014	M8	14	25x20	
161.M08.125.012	M8	12	25x25	
161.M06.100.012	M6	12	30x08 30x10	
161.M08.125.012	M8	12	30x12	
161.M08.125.018	M8	18	30x16	
161.M08.125.016	M8	16	30x20	
161.M08.125.012	M8	12	30x32	
161.M10.150.012	M10	12	30x40	
161.M06.100.012	M6	12	40x08	
161.M08.125.012	M8	12	40x10 40x12	
161.M10.150.018	M10	18	40x16	
161.M10.150.016	M10	16	40x20	
161.M10.150.014	M10	14	40x25	
161.M10.150.016	M10	16	40x32	
161.M10.150.012	M10	12	40x40	

Bestell-Nr. Order Nr. Référence Sipariş Nr.	DIN 913 M	L	Form E2 d1xd2	Euro
161.M08.125.016	M8	16	50x12	
161.M10.150.016	M10	16	50x16	
161.M12.175.014	M12	14	50x20 50x25	
161.M12.175.020	M12	20	50x32	
161.M12.175.016	M12	16	50x40	
161.M12.175.012	M12	12	50x50	

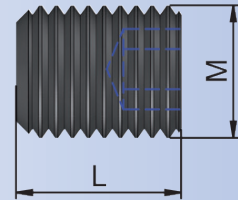

## Anschlagschraube



Stop screw

Vis ajuster

Dayama civatası

Bestell-Nr. Order Nr. Référence Sipariş Nr.	DIN 916 M	L	SK-BT Whistle Notch Ø	Euro
165.1.M05.080.016	M5	16	6	
165.1.M06.100.016	M6	16	8	
165.1.M08.125.020	M8	20	10	
165.1.M10.150.025	M10	25	12-14	
165.1.M12.175.025	M12	25	16-18	
165.1.M16.200.025	M16	25	20	
165.1.M20.250.030	M20	30	25-32-40	

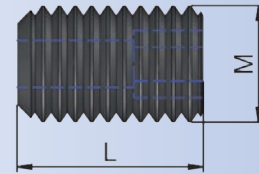

Bestell-Nr. Order Nr. Référence Sipariş Nr.	DIN 916 M	L	HSK A Whistle Notch Ø	Euro
165.1.M05.080.016	M5	16	6	
165.1.M06.100.016	M6	16	8	
165.1.M08.125.016	M8	16	10	
165.1.M10.150.016	M10	16	12-14	
165.1.M12.175.016	M12	16	16-18	
165.1.M12.175.020	M12	20	20-25-32	
165.1.M12.175.012	M12	12	40	

Bestell-Nr. Order Nr. Référence Sipariş Nr.	DIN 916 M	L	HSK C Whistle Notch Ø	Euro
165.1.M05.080.012	M5	12	6	
165.1.M06.100.012	M6	12	8	
165.1.M08.125.012	M8	12	10	
165.1.M10.150.012	M10	12	14	
165.1.M12.175.012	M12	12	16-18-20	
165.1.M12.175.016	M12	16	25-32	



## Anschlagschraube

Stop screw

Vis ajuster

Dayama civatası

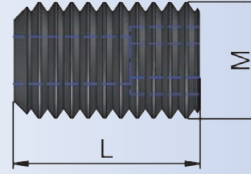

Bestell-Nr. Order Nr. Référence Sipariş Nr.	DIN 916 M	L	Shirink Ø	Abmessung Size Dimension Cinsi	Euro
165.1.M04.070.010	M4	10	03	HSK32	
165.1.M05.080.016	M5	16		SK30/HSK40-50-63/EP63	
165.1.M06.100.016	M6	16		SK40-50/BT30-40-50	
165.1.M05.080.016	M5	16	03 Slim	SK/BT/HSK/EP63	
165.1.M04.070.010	M4	10	04	HSK32	
165.1.M05.080.016	M5	16		HSK40	
165.1.M06.100.016	M6	16		SK/BT/HSK50-63/EP63	
165.1.M05.080.016	M5	16	04 Slim	SK40-50/BT40-50	
165.1.M06.100.016	M6	16		HSK63/EP63	
165.1.M04.070.010	M4	10	05	HSK32-40	
165.1.M06.100.016	M6	16		SK/BT/HSK50-63/EP63	
165.1.M06.100.016	M6	16	05 Slim	SK/BT/HSK/EP63	
165.1.M05.080.016	M5	16	06	SK/BT/HSK/EP63	
165.1.M06.100.016	M6	16	06 Slim	SK/BT/HSK/EP63	
			08		
165.1.M08.125.008	M8	8	10	HSK32	
				SK/BT/HSK40-50-63-80-100/EP50-63	
165.1.M08.125.016	M8	16	10 Slim	SK/BT/HSK/EP63	
165.1.M08.125.010	M8	10	12	HSK32	
165.1.M10.150.016	M10	16		SK/BT/HSK40-50-60-80-100/EP63	
165.1.M10.150.016	M10	16	12 Slim	SK/BT/HSK/EP63	
165.1.M10.150.016	M10	16	14	SK/BT/HSK/EP63	
165.1.M10.150.010	M10	10		HSK40-50	
165.1.M10.150.016	M10	16	16	EP63-80	
				SK/BT/EP63-80	
165.1.M12.175.016	M12	16	16 Slim	HSK100	
165.1.M12.175.016	M12	16	18	SK/BT/HSK/EP63	
			20	SK/BT/HSK/EP63	
			25	SK/BT/HSK/EP63	
			32	HSK63-80-100/EP50-63-80	
165.1.M16.200.020	M16	20	32	SK/BT	

## Anschlagschraube



Stop screw

Vis ajuster

Dayama civatası

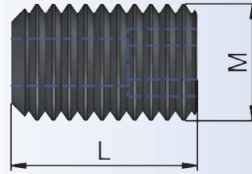

Bestell-Nr. Order Nr. Référence Sipariş Nr.	DIN 916		Hydraulic Ø	Abmessung Size Dimension Cinsi	Euro
	M	L			
165.1.M05.080.006	M5	6	06	HSK100/EPS63	
165.1.M05.080.010	M5	10		HSK40-50-60/EPS50	
165.1.M05.080.016	M5	16		SK/BT/EPS40	
165.1.M06.100.006	M6	6	08	HSK50-63-100/EPS50-63	
165.1.M06.100.016	M6	16		SK/BT/HSK63 Long	
165.1.M08.125.010	M8	10	10	HSK50-63/EPS63	
165.1.M08.125.016	M8	16		SK/BT/HSK63 Long-100/EPS40-50	
165.1.M10.150.010	M10	10	12	HSK40-50-63	
165.1.M10.150.016	M10	16		SK/BT/HSK63 Long-100	
165.1.M10.150.010	M10	10	14	HSK40-50-63	
165.1.M10.150.016	M10	16		SK/BT/HSK63 Long-100/EPS50-63	
165.1.M12.175.010	M12	10	16	HSK40-50-63	
165.1.M12.175.016	M12	16		SK/BT/HSK63 Long-100/EPS50-63	
165.1.M12.175.010	M12	10	18	HSK40-50-63	
165.1.M12.175.016	M12	16		SK/BT/HSK63 Long-100/EPS50-63	
165.1.M08.100.008	M8x1	8	20	A63.65.20.80	
165.1.M10.150.010	M10	10		HSK50	
165.1.M10.150.012	M10	12		EPS63	
165.1.M10.150.016	M10	16		EPS50	
165.1.M12.175.010	M12	10		HSK63/403.65.20.64/406.65.20.72	
165.1.M12.175.016	M12	16		HSK63 Long-100	
165.1.M12.175.020	M12	20		SK/BT/EPS80	
165.1.M12.175.016	M12	16	25	EPS50-63	
165.1.M16.200.016	M16	16		SK/BT/HSK	
165.1.M12.175.010	M12	10	32	503.65.32.81	
165.1.M12.100.012	M12x1	12		506.65.32.90	
165.1.M16.200.016	M16	16		SK/BT/HSK/EPS	



## Paßfeder

Feather Key

Ressort de passage

Kama

Bestell-Nr. Order Nr. Référence Sipariş Nr.	h b L	DIN 913	Euro
10.16.4	4 x 4 x 20	M2x4	
10.22.6	6 x 6 x 25	M3 x 5	
10.27.7	7 x 7 x 25	M3 x 6	
10.32.8	8 x 7 x 28	M3 x 6	
10.40.10	10 x 8 x 32	M3 x 6	



## Mitnehmersteine mit Schraube

Drive Key

Entraineur

Vidalı Kama

Bestell-Nr. Order Nr. Référence Sipariş Nr.	h b L	DIN 912	Euro
11.16.8	8 x 10x9,8	M3 x 12	
11.22.10	10 x 11 x 11,2	M4 x 12	
11.27.12	12 x 14x 12,6	M4 x 16	
11.32.14	14 x 22 x 14	M5 x 16	
11.40.16	16 x 23 x 16	M5 x 20	
11.50.18	18 x 32 x 18	M6 x 20	
11.60.25	25,4 x 26,5 x 25	M12 x 25	

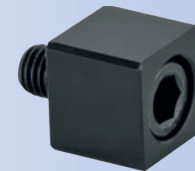
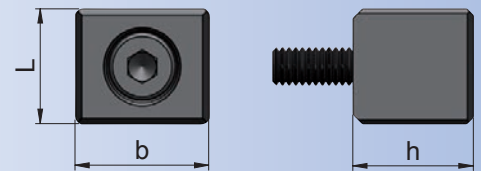

## Unterlegplatte

VDI 3425

Shim

Plaque entretoise

Kater laması

Bestell-Nr. Order Nr. Référence Sipariş Nr.	B x H x L	Euro
169.12.01	10 x 3,95 x 41	
209.16.01	13 x 3,95 x 49	
309.20.01	17 x 3,95 x 69	
409.25.01	21 x 4,95 x 84	
509.32.01	24 x 6,95 x 99	

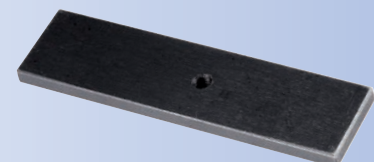
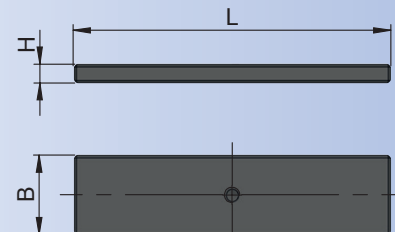

## Fräseranzugsschrauben DIN 6367



Drawn in bolt DIN 6367

Vis de serrage DIN 6367

Tarama başlık sıkma civatası DIN 6367

Bestell-Nr. Order Nr. Référence Sipariş Nr.	Abmessung Size Dimension Cinsi	M	D	K	L	Euro
102.10.16	16	M8	20	6	16	
102.10.22	22	M10	28	7	18	
102.10.27	27	M12	35	8	22	
102.10.32	32	M16	42	9	26	
102.10.40	40	M20	52	10	30	
102.10.50	50	M24	63	12	36	
102.10.60	60	M30	75	14	45	

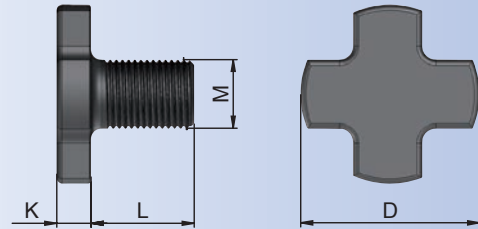

## Fräseranzugsschrauben DIN 6367 durchgebohrt für Kühlmittelzufuhr

Drawn in bolt bored through for coolant DIN 6367

Vis de serrage DIN 6367 percée pour l'arrosage par la collerette

Tarama başlık sıkma civatası DIN 6367 içten soğutmalı

Bestell-Nr. Order Nr. Référence Sipariş Nr.	Abmessung Size Dimension Cinsi	M	D	K	L	Euro
102.11.16	16	M8	20	6	16	
102.11.22	22	M10	28	7	18	
102.11.27	27	M12	35	8	22	
102.11.32	32	M16	42	9	26	
102.11.40	40	M20	52	10	30	
102.11.50	50	M24	63	12	36	
102.11.60	60	M30	75	14	45	

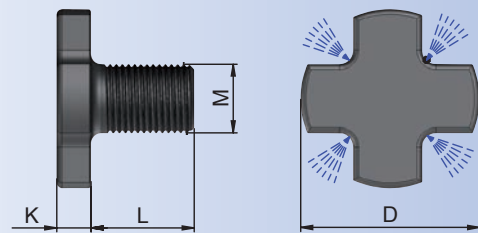



## Mitnehmerringe DIN 6366

Clutch drive rings to DIN 6366

Bague d'entrainement DIN 6366

Tırnaklı pul DIN 6366

Bestell-Nr. Order Nr. Référence Sipariş Nr.	d	D	a	b	h	Euro
101.10.16	16	32	10	8	5	
101.10.22	22	40	12	10	5,6	
101.10.27	27	48	12	12	6,3	
101.10.32	32	58	14	14	7	
101.10.40	40	70	14	16	8	

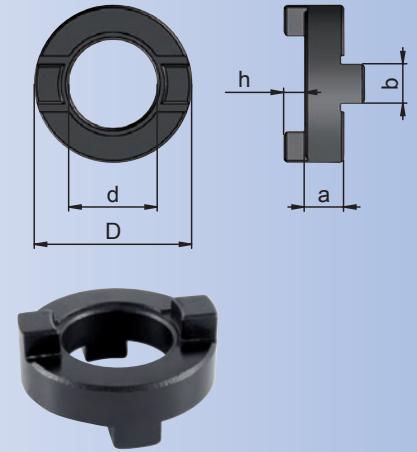

## Spannschlüssel DIN 6368 für Aufsteckdorne

Wrench DIN 6368

Clé de serrage DIN 6368

Tarama başlık civatası sıkma anahtarı DIN 6368

Bestell-Nr. Order Nr. Référence Sipariş Nr.	D	Euro
10.16	16/M8	
10.22	22/M10	
10.27	27/M12	
10.32	32/M16	
10.40	40 / M20	
10.50	50 / M24	
10.60	60 / M30	

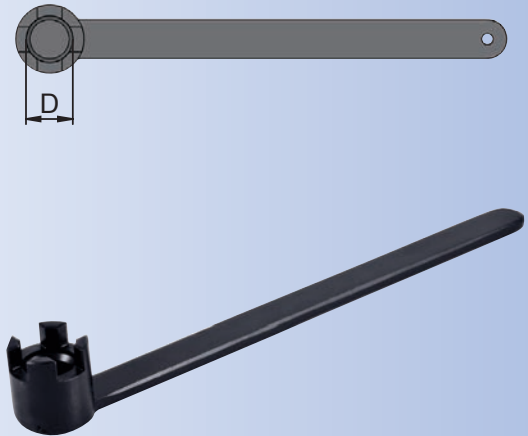

## Hakenschlüssel DIN 1810 A für OZ - Spannmuttern

Wrench DIN 1810 A

Clé à ergot DIN 1810 A

E tipi ay anahtar DIN 1810 A

Bestell-Nr. Order Nr. Référence Sipariş Nr.	Abmessung Size Dimension Cinsi	D	Euro
01.16	415 E (2-16)	40-42	
01.25	462 E (2-25)	58-62	
01.32	467 E (3-32)	68-75	

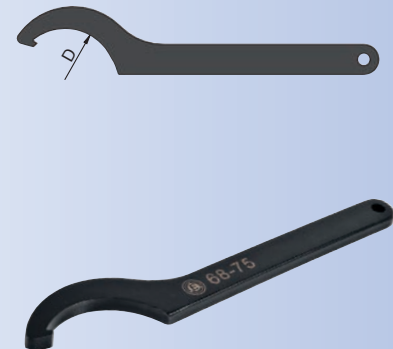



## Rollenschlüssel für ER - Spannmuttern / Präzisionskraftspannfutter



Wrench for ER - Precision milling chuck

Clé pour ER - Mandrin de fraisage de précision

ER tipi ve bilyalı pens tutucu için anahtar

Bestell-Nr. Order Nr. Référence Sipariş Nr.	Abmessung Size Dimension Cinsi	D	Euro
<b>new</b> 02.05.10	ER 8 (1-5)	10	
<b>new</b> 02.07.16	ER 11 (1-7)	16	
<b>new</b> 02.10.22	ER 16 (1-10)	22	
<b>new</b> 02.10.24	ER 16 (1-10)	24	
<b>new</b> 02.10.30	ER 16(1-10)	30	
<b>new</b> 02.10.32	ER 16 (1-10)	32	
<b>new</b> 02.13.35	ER 20 (1-13)	35	
<b>new</b> 02.16.40	ER 25 (2-16)	40	
<b>new</b> 02.16.42	ER 25 (2-16)	42	
<b>new</b> 02.20.50	ER 32 (2-20)	50	
<b>new</b> 02.26.63	ER 40 (3-26)	63	
<b>new</b> 03.20.N	EKS 20 (16-20)	48	
<b>new</b> 03.32.N	EKS 32 (16-32)	68	

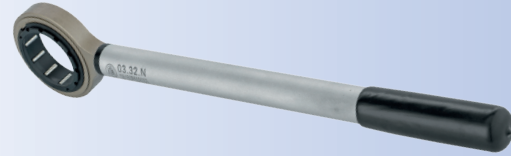



## Spannschlüssel für ER Spannmutter

**Wrench ER**

**Clé de serrage ER**

**ER tipi anahtar**

Bestell-Nr. Order Nr. Référence Sipariş Nr.	Abmessung Size Dimension Cinsi	D	Euro
* 02.10	1 - 10 (ER16)	28 sw 25	
02.10.1	1 - 10 (ER16)	32	
* 02.10.2	1 - 10 (ER16)	30 sw 27	
* 02.13	1 - 13 (ER20)	35 sw 30	
02.13.1	1 - 13 (ER20)	35	
02.16	2 - 16 (ER25)	42	
02.20	2 - 20 (ER32)	50	
02.26	3 - 26 (ER40)	63	

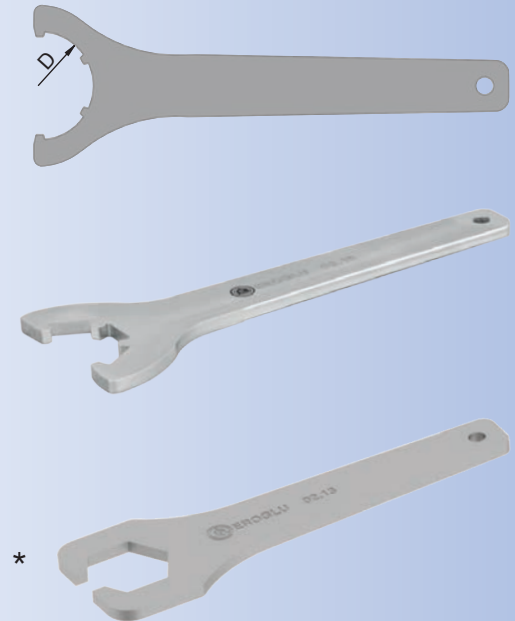

## Spannschlüssel für ER Mini

**Wrench ER Mini**

**Clé de serrage ER Mini**

**ER tipi anahtar mini**

Bestell-Nr. Order Nr. Référence Sipariş Nr.	Abmessung Size Dimension Cinsi	D	Euro
02.05.M	1 - 5 (ER8)	12	
02.07.M	1-7 (ER11)	16	
02.10.M	1 -10 (ER16)	22	

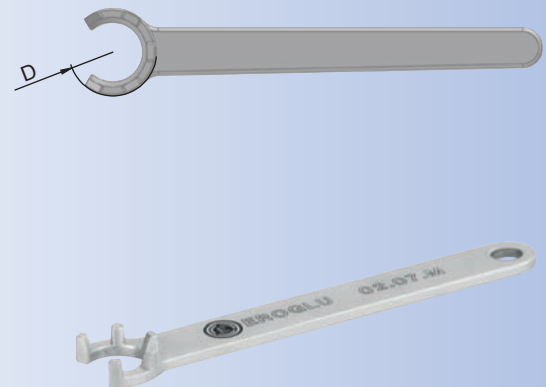

## Ausziehschlüssel für Reduzierhülsen der Hydrodehnspannfutter

**Wrench reducing arbor for hydraulic expansion chuck**

**Clé pour les douilles de réduction pour les mondrins expansibles hydraulique**

**Hidrolik Pens Sökme Anahtarı**

Bestell-Nr. Order Nr. Référence Sipariş Nr.	Abmessung Size Dimension Cinsi	Euro
<b>new</b> 65.01	R12 / R20 / R32	





## Spanschlüssel

### Wrench

### Clé de serrage

### Sıkma anahtarı

Bestell-Nr. Order Nr. Référence Sipariş Nr.	SW	Typ	L	Euro
15.04	4	NC	100	
15.06	6	NC	100	
65.05	5	HDS	100	

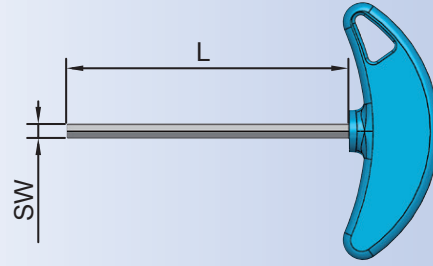

## Bohrfutter

### Drill chuck

### Mandrin de perçage á serrage

### Süper supra mandren

Bestell-Nr. Order Nr. Référence Sipariş Nr.	B	Spannbereich Capacity Capacité Kapasite	D	L	Euro
14.13.B16	B16	0-13	50	92	
14.16.B16	B16	3-16	57	95	

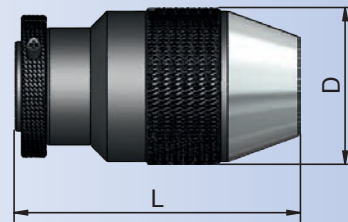



## Kühlmittelübergabeeinheit

Delivery unit for coolant

Unité de transmission de liquide de refroidissement par le centre

Soğutma suyu ünitesi

Bestell-Nr. Order Nr. Référence Sipariş Nr.	HSK-A	D	d	L	Euro
A32.700	HSK-A 32	M10 x 1	6	26,0	
A40.700	HSK-A 40	M12 x 1	8	29,5	
A50.700	HSK-A 50	M16 x 1	10	33,0	
A63.700	HSK-A 63	M18 x 1	12	34,5	
A80.700	HSK-A 80	M20 x 1,5	14	40,0	
A100.700	HSK-A 100	M24 x 1,5	16	44,0	

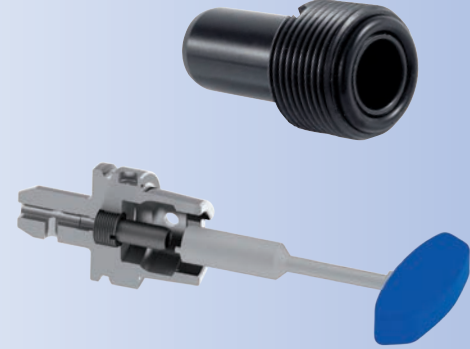
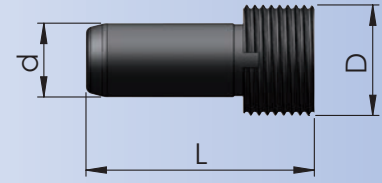

## Schlüssel für Kühlmittelübergabeeinheit

Wrench for delivery unit for coolant

Clé pour raccord d'arrodage

Soğutma suyu ünitesi anahtarı

Bestell-Nr. Order Nr. Référence Sipariş Nr.	HSK-A	D	L	Euro
A32.701	HSK-A 32	8,5	115	
A40.701	HSK-A 40	10,5	115	
A50.701	HSK-A 50	14,5	115	
A63.701	HSK-A 63	16,5	136	
A80.701	HSK-A 80	18,5	136	
A100.701	HSK-A 100	22,0	136	

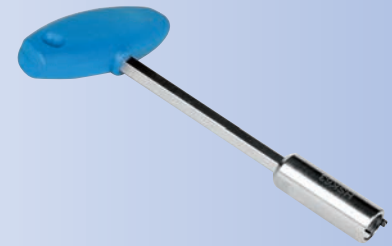
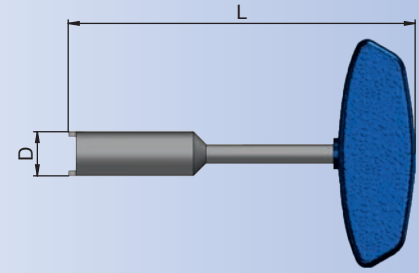

## Kunststoff - Kugelspritzdüse

Plastic ball sprayer nozzle

Buse d'injection spherique en plastique

Su verme misketi

Bestell-Nr. Order Nr. Référence Sipariş Nr.	D	Euro
703.08	8	
703.10	10	
703.12	12	
703.14	14	

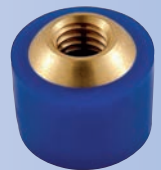



## Verschraubung

### Ball cooling pipe with nut

### Boule frais tube avec vissage

### Somunlu su verme misketi

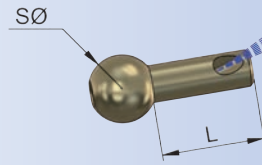

Bestell-Nr. Order Nr. Référence Sipariş Nr.	M	SØ	L	Euro
--	---	----	---	------

<b>new</b>	703.M10.15	M10x1	8	15	
<b>new</b>	703.M10.30	M10x1	8	30	
<b>new</b>	703.M10.50	M10x1	8	50	

<b>new</b>	703.M12.15	M12x1	10	15	
<b>new</b>	703.M12.30	M12x1	10	30	
<b>new</b>	703.M12.50	M12x1	10	50	

<b>new</b>	* 704.M10	M10x1	-	-	
<b>new</b>	* 704.M12	M12x1	-	-	

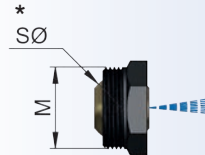
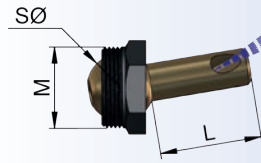

Bestell-Nr. Order Nr. Référence Sipariş Nr.	SØ	L	Euro
--	----	---	------

<b>new</b>	703.S08.15	8	15	
<b>new</b>	703.S08.30	8	30	
<b>new</b>	703.S08.50	8	50	

<b>new</b>	703.S10.15	10	15	
<b>new</b>	703.S10.30	10	30	
<b>new</b>	703.S10.50	10	50	

Bestell-Nr. Order Nr. Référence Sipariş Nr.	M	Euro
--	---	------

<b>new</b>	703.M10	M10x1	
<b>new</b>	703.M12	M12x1	

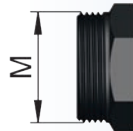

## Kegelwischer

### Taper wiper

### Cônes de nettoyage

### Konik temizleyici

Bestell-Nr. Order Nr. Référence Sipariş Nr.	Abmessung Size Dimension Cinsi	Euro
--	---	------

710.01	MK 1	
710.02	MK 2	
710.03	MK 3	
710.04	MK 4	
710.05	MK 5	

710.30	SK 30	
710.40	SK 40	
710.50	SK 50	

710.32.HSK	HSK 32	
710.40.HSK	HSK 40	
710.50.HSK	HSK 50	
710.63.HSK	HSK 63	
710.80.HSK	HSK 80	
710.100.HSK	HSK 100	



MK



SK

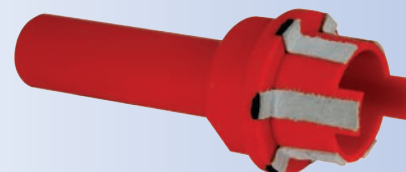

HSK



## Montageblock aus Stahl, schwenkbar

Universal assembly block steel

Bloc de montage universel en fer

Çelik montaj aparatı sağa ve sola 90° dönebilen

Bestell-Nr. Order Nr. Référence Sipariş Nr.	Abmessung Size Dimension Cinsi	L	H	B	Euro
705.30	SK 30	125	121	64	
705.40	SK 40	130	136	64	
705.50	SK 50	170	170	72	
709.16	VDI 16	100	97	48	
709.20	VDI20	100	97	48	
709.25	VDI 25	100	97	48	
709.30	VDI 30	130	121	64	
709.40	VDI 40	130	136	64	
709.50	VDI 50	170	170	72	
708.32	HSK32	100	97	48	
708.40	HSK40	100	97	48	
708.50	HSK50	125	121	64	
708.63	HSK63	130	136	64	
708.80	HSK80	170	170	72	
708.100	HSK100	170	170	72	

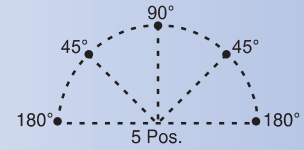
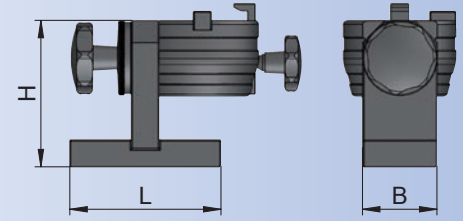

## Montageblock aus Stahl

Assembly block steel

Bloc de montage

Çelik montaj aparatı

Bestell-Nr. Order Nr. Référence Sipariş Nr.	Abmessung Size Dimension Cinsi	L	H	B	Euro
<b>new</b> 707.30	ISO 30	127	75	47	
<b>new</b> 707.40	ISO 40	160	105	62	
<b>new</b> 707.50	ISO 50	180	155	99	

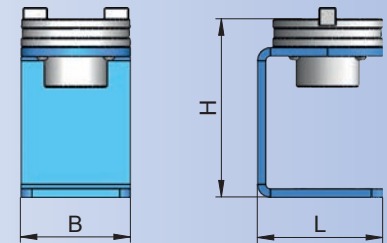



## Schnellmontageblock mit Rollenlager aus Stahl, Universal

### Fast-mounting assembly block steel, universal

### Bloc de montage rapide de l'acier, universel

### Pratik universal çelik montaj aparatı

Bestell-Nr. Order Nr. Référence Sipariş Nr.	Abmessung Size Dimension Cinsi	D	Euro
705.40/63	SK 40-BT 40-HSK 63-EPS 63	63	

- \* Zur Aufnahme von HSK 63 - EPS 63 - SK 40 - BT 40  
For clamping of HSK 63 - EPS 63 - SK 40 - BT 40  
Pour le serrage de HSK 63 - EPS 63 - SK 40 - BT 40  
HSK 63 - EPS 63 - SK 40 - BT 40 tipi başlıklar için

- \* 45° und 90° - 5 verschiedene Positionen verwendbar  
45° and 90° - can be used in 5 different positions  
45° et 90° - 5 différentes positions applicables  
45° ve 90° - 5 ayrı pozisyonda kullanılabilir

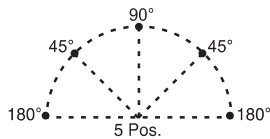

- \* Gesichert gegen Herausfallen durch Arretierung  
Secured against falling down with adjustment lock  
Assuré contre tomber par un blocage  
Takımlar aparat içinde pozisyonlarda kilitleyerek düşmesi engellenir

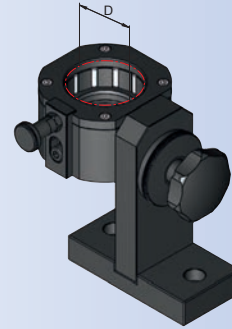

- \* Klemmung über Rollenlager am Bund ohne Kontakt des Kegels  
Clamping with sliding-contact bearings at the flange,  
no contact with cone  
Serrage sur le roulement à galets à l'embase sans contact du cône  
Koniğe temas etmeden dış çaptan bilyalar sayesinde sıkıştırılabilir

## Schnellmontageblock aus Stahl mit Rollenlager

### Quick-change mounting assembly block steel, with roller bearings

### Bloc de montage rapide de l'acier avec roulements a roulex

### Bilyalı çelik montaj aparatı

Bestell-Nr. Order Nr. Référence Sipariş Nr.	Abmessung Size Dimension Cinsi	D	L	H	B	Euro
<b>new</b> 706.30	BT 30	46	111	165	88	
<b>new</b> 706.32	HSK 32 - EPS 32	32	85	120	74	
<b>new</b> 706.40	HSK 40 - EPS 40	40	85	120	74	
<b>new</b> 706.50	SK 30 - HSK 50 - EPS 50	50	111	165	88	
<b>new</b> 706.50.1	SK 50	97,5	160	209	144	
<b>new</b> 706.63	SK 40 - BT 40- HSK 63 - EPS 63	63	114	170	100	
<b>new</b> 706.80	HSK 80 - EPS 80	80	130	175	122	
<b>new</b> 706.100	HSK 100 - BT 50	100	160	209	144	

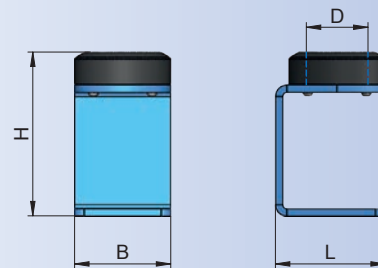



## Montageblock aus Aluminium

Tightening fixtures Aluminium

Bloc de montage en aluminium

Montaj aparatı alüminyum

Bestell-Nr. Order Nr. Référence Sipariş Nr.	Abmessung Size Dimension Cinsi	L	H	B	Euro
700.30	SK 30	127	75	47	
700.40	SK 40	160	105	62	
700.50	SK 50	180	155	99	

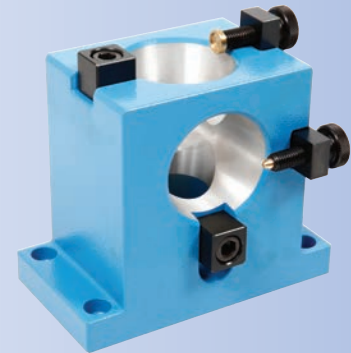
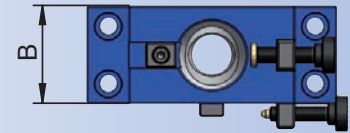
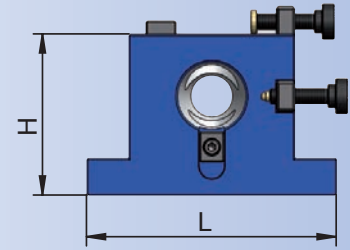

## NC - Bohrfutter mit MK Schaft für Rechts - und Linkslauf MK / DIN 228 Form B

NC - Drill chucks with MK shaft for left and right rotation MK / DIN 228 Form B

Mandrin de perçage CNC avec cône morse pour rotation gauche-droite MK / DIN 228 Forme B

MK şaftlı NC tipi mandren malafası komple sağ ve sol dönüşlü MK / DIN 228 Form B

Bestell-Nr. Order Nr. Référence Sipariş Nr.	MK	Spannbereich Capacity Capacité Kapasite	d	A	D	Euro
<b>new</b> 082.15.08.75	2	0,5 - 8	75	36		
<b>new</b> 082.15.13.105	2	1,0 - 13	105	50		
<b>new</b> 082.15.16.110	2	3,0 - 16	110	57		
<b>new</b> 083.15.08.75	3	0,5 - 8	75	36		
<b>new</b> 083.15.13.100	3	1,0 - 13	100	50		
<b>new</b> 083.15.16.105	3	3,0 - 16	105	57		
<b>new</b> 084.15.13.104	4	1,0 - 13	104	50		
<b>new</b> 084.15.16.109	4	3,0 - 16	109	57		

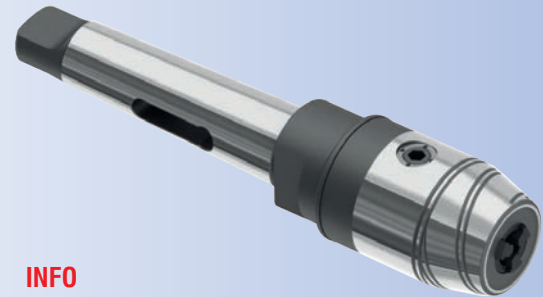
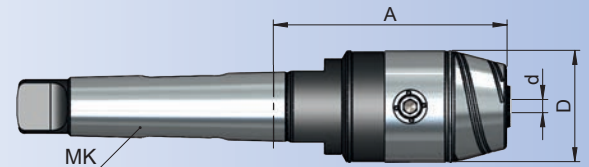

## Zubehör / Accessories / Accessoires / Yedekler



Ersatzteile  
Spare Parts  
Pièce de rechange  
Yedek parçalar



Spannschlüssel  
Wrench  
Clé de serrage  
Sıkma anahtarı

9.54

## INFO

Technische Daten	10.06
Technical Data	10.06
Données Techniques	10.06
Teknik Bilgi	10.06



## Ersatzteilleiste 08



### Spare Parts 08

### Liste des pièces de rechange 08

### Yedek parça listesi 08

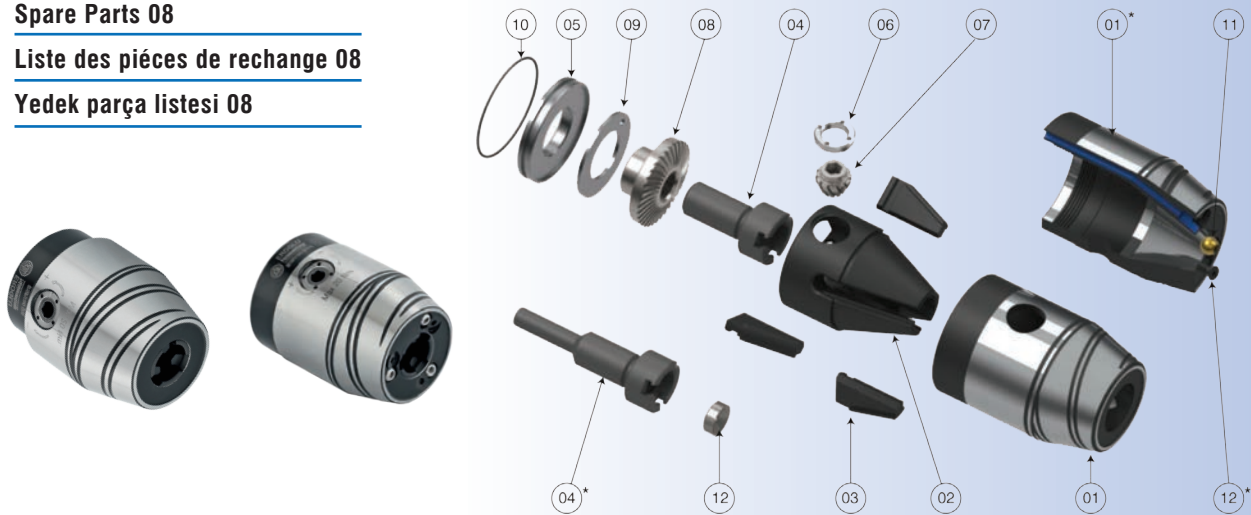

#### 15.08.S

No	Bezeichnung	Type	Désignation	Cinsi	Bestell-Nr.	Order Nr.	Référence	Sipariş Nr.	Euro
1	Hülse	Shell	Douille	Ana gövde			15.08.11.1		
2	Spreizkonus	Spreader cone	Cône d'expansion	İç kovan			15.08.13.1		
3	Spannbacke (1 Satz / 3 Stück)	Clamping jaw (1 Set / 3 piece)	Mâchoire de serrage (1 jeu / 3 pieces)	Tırnak (1 Set / 3 adet)			15.08.14		
4	Spindel	Spindle	Arbre	Çektirme civatası			15.08.15		
5	Druckstück	Thrust member	Piece recevant la pression	Çelik pul			15.08.19.1		
6	Ritzelschraube	Pinion bolt	Vis de pignon	Pinyon dişli sıkma somunu			15.08.20.1		
7	Ritzel	Pinion	Pignon	Pinyon dişli			15.08.17		
8	Kegelrad	Bevel gear	Rou conique	Ayna dişli			15.08.18		
9	Anlaufscheibe	Thrust washer	Plaque de butee	Teflon pul			15.08.22		
10	O-Ring-Ø25x1	O-Ring-Ø25x1	O-Ring-Ø25x1	O-ring-Ø25x1			15.08.23		

#### 15.08.IK

No	Bezeichnung	Type	Désignation	Cinsi	Bestell-Nr.	Order Nr.	Référence	Sipariş Nr.	Euro
1	Hülse	Shell	Douille	Ana gövde			15.08.11.1		
2	Spreizkonus	Spreader cone	Cône d'expansion	İç kovan			15.08.13.1		
3	Spannbacke (1 Satz / 3 Stück)	Clamping jaw (1 Set / 3 piece)	Mâchoire de serrage (1 jeu / 3 pieces)	Tırnak (1 Set / 3 adet)			15.08.14		
4	* Spindel	* Spindle	* Arbre	* Çektirme civatası			15.08.16		
5	Druckstück	Thrust member	Piece recevant la pression	Çelik pul			15.08.19.1		
6	Ritzelschraube	Pinion bolt	Vis de pignon	Pinyon dişli sıkma somunu			15.08.20.1		
7	Ritzel	Pinion	Pignon	Pinyon dişli			15.08.17		
8	Kegelrad	Bevel gear	Rou conique	Ayna dişli			15.08.18		
9	Anlaufscheibe	Thrust washer	Plaque de butee	Teflon pul			15.08.22		
10	O-Ring-Ø25x1	O-Ring-Ø25x1	O-Ring-Ø25x1	O-ring-Ø25x1			15.08.23		
12	Dichtscheibe	Gasket	Rondelie d'etancheite	Polyemid pul			15.08.26		

#### 15.08.K

No	Bezeichnung	Type	Désignation	Cinsi	Bestell-Nr.	Order Nr.	Référence	Sipariş Nr.	Euro
1	* Hülse	* Shell	* Douille	* Ana gövde			15.08.12.1		
2	Spreizkonus	Spreader cone	Cône d'expansion	İç kovan			15.08.13.1		
3	Spannbacke (1 Satz / 3 Stück)	Clamping jaw (1 Set / 3 piece)	Mâchoire de serrage (1 jeu / 3 pieces)	Tırnak (0-8 için)			15.08.14		
4	Spindel	Spindle	Arbre	Çektirme civatası			15.08.15		
5	Druckstück	Thrust member	Piece recevant la pression	Çelik pul			15.08.19.1		
6	Ritzelschraube	Pinion bolt	Vis de pignon	Pinyon dişli sıkma somunu			15.08.35.1		
7	Ritzel	Pinion	Pignon	Pinyon dişli			15.08.17		
8	Kegelrad	Bevel gear	Rou conique	Ayna dişli			15.08.18		
9	Anlaufscheibe	Thrust washer	Plaque de butee	Teflon pul			15.08.22		
10	O-Ring-Ø25x1	O-Ring-Ø25x1	O-Ring-Ø25x1	O-ring-Ø25x1			15.08.23		
11	Kugel	Ball	Bille	Su gözü			15.08.29		
12	* Senkschraube	* Countersunk head screw	* Vis à tête conique	* Su gözü sıkma civatası			15.08.30		



## Ersatzteilleiste 13

### Spare Parts 13

### Liste des pièces de rechange 13

### Yedek parça listesi 13

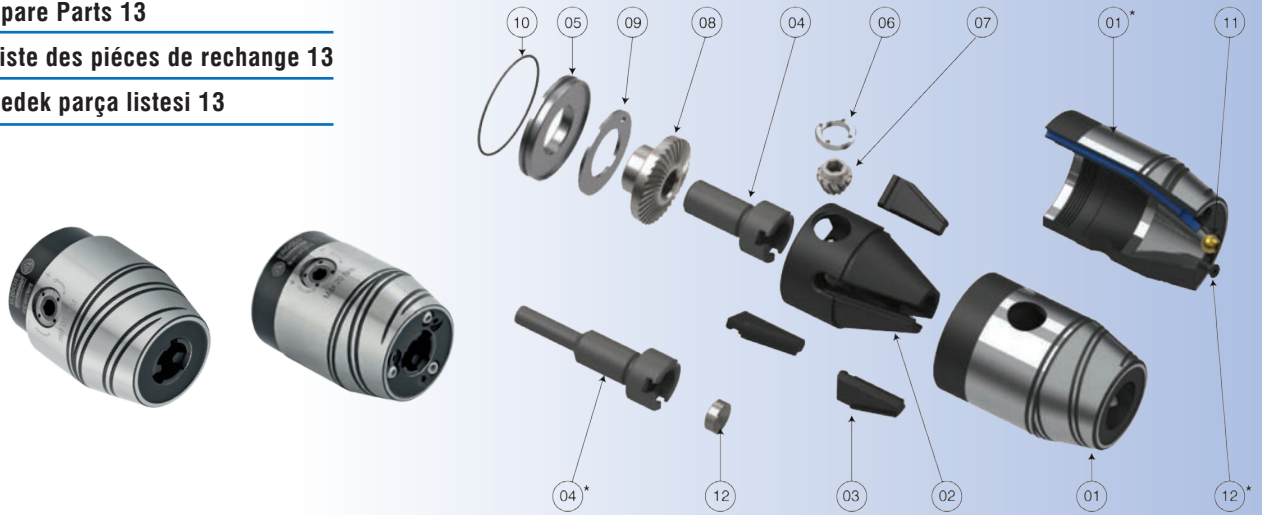

#### 15.13.S

No	Bezeichnung	Type	Désignation	Cinsi	Bestell-Nr.	Order Nr.	Référence	Sipariş Nr.	Euro
1	Hülse	Shell	Douille	Ana gövde			15.13.11.1		
2	Spreizkonus	Spreader cone	Cône d'expansion	İç kovan			15.13.13.1		
3	Spannbacke (1 Satz / 3 Stück)	Clamping jaw (1Set / 3 piece)	Mâchoire de serrage (1 jeu / 3 pieces)	Tırnak (1 Set / 3 adet)			15.13.14		
4	Spindel	Spindle	Arbre	Çektirme civatası			15.13.15		
5	Druckstück	Thrust member	Piece recevant la pression	Çelik pul			15.13.20.1		
6	Ritzelschraube	Pinion bolt	Vis de pignon	Pinyon dişli sıkma somunu			15.13.21.1		
7	Ritzel	Pinion	Pignon	Pinyon dişli			15.13.18		
8	Kegelrad	Bevel gear	Rou conique	Ayna dişli			15.13.19		
9	Anlaufscheibe	Thrust washer	Plaque de butee	Teflon pul			15.13.23		
10	O-ring-Ø40x1.5	O-ring-Ø40x1.5	O-ring-Ø40x1.5	O-ring-Ø40x1.5			15.13.24		

#### 15.13.IK

No	Bezeichnung	Type	Désignation	Cinsi	Bestell-Nr.	Order Nr.	Référence	Sipariş Nr.	Euro
1	Hülse	Shell	Douille	Ana gövde			15.13.11.1		
2	Spreizkonus	Spreader cone	Cône d'expansion	İç kovan			15.13.13.1		
3	Spannbacke (1 Satz / 3 Stück)	Clamping jaw (1Set / 3 piece)	Mâchoire de serrage (1 jeu / 3 pieces)	Tırnak (1 Set / 3 adet)			15.13.14		
4	* Spindel	* Spindle	* Arbre	* Çektirme civatası			15.13.16		
5	Druckstück	Thrust member	Piece recevant la pression	Çelik pul			15.13.20.1		
6	Ritzelschraube	Pinion bolt	Vis de pignon	Pinyon dişli sıkma somunu			15.13.21.1		
7	Ritzel	Pinion	Pignon	Pinyon dişli			15.13.18		
8	Kegelrad	Bevel gear	Rou conique	Ayna dişli			15.13.19		
9	Anlaufscheibe	Thrust washer	Plaque de butee	Teflon pul			15.13.23		
10	O-ring-Ø40x1.5	O-ring-Ø40x1.5	O-ring-Ø40x1.5	O-ring-Ø40x1.5			15.13.24		
12	Dichtscheibe	Gasket	Rondelle d'étancheite	Polyemid pul			15.13.28		

#### 15.13.K

No	Bezeichnung	Type	Désignation	Cinsi	Bestell-Nr.	Order Nr.	Référence	Sipariş Nr.	Euro
1	* Hülse	* Shell	* Douille	* Ana gövde			15.13.12.1		
2	Spreizkonus	Spreader cone	Cône d'expansion	İç kovan			15.13.13.1		
3	Spannbacke (1 Satz / 3 Stück)	Clamping jaw (1Set / 3 piece)	Mâchoire de serrage (1 jeu / 3 pieces)	Tırnak (1 Set / 3 adet)			15.13.14		
4	Spindel	Spindle	Arbre	Çektirme civatası			15.13.15		
5	Druckstück	Thrust member	Piece recevant la pression	Çelik pul			15.13.20.1		
6	Ritzelschraube	Pinion bolt	Vis de pignon	Pinyon dişli sıkma somunu			15.13.35.1		
7	Ritzel	Pinion	Pignon	Pinyon dişli			15.13.18		
8	Kegelrad	Bevel gear	Rou conique	Ayna dişli			15.13.19		
9	Anlaufscheibe	Thrust washer	Plaque de butee	Teflon pul			15.13.23		
10	O-Ring-Ø40x1.5	O-Ring-Ø40x1.5	O-Ring-Ø40x1.5	O-ring-Ø40x1.5			15.13.24		
11	Kugel	Ball	Bille	Su gözü			15.13.33		
12	* Senkschraube	* Countersunk head screw	* Vis à tête conique	*Su gözü sıkma civatası			15.13.34		

## Ersatzteilleiste 16



### Spare Parts 16

### Liste des pièces de rechange 16

### Yedek parça listesi 16

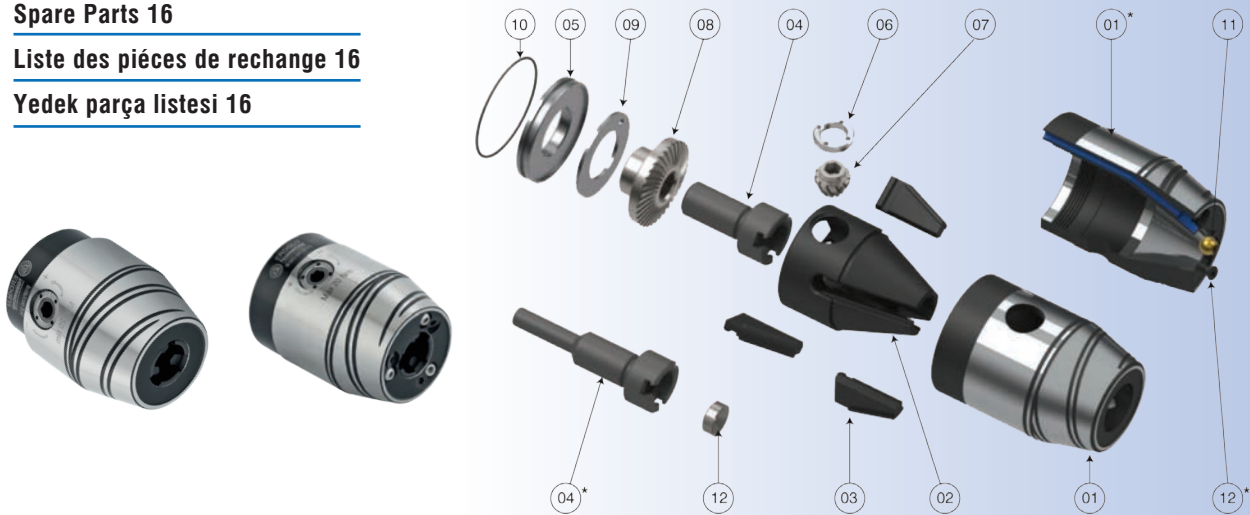

#### 15.16.S

No	Bezeichnung	Type	Désignation	Cinsi	Bestell-Nr.	Order Nr.	Référence	Sipariş Nr.	Euro
1	Hülse	Shell	Douille	Ana gövde			15.16.11.1		
2	Spreizkonus	Spreader cone	Cône d'expansion	İç kovan			15.16.13.1		
3	Spannbacke (1 Satz / 3 Stück)	Clamping jaw (1Set / 3 piece)	Mâchoire de serrage (1 jeu / 3 pieces)	Tırnak (1 Set / 3 adet)			15.13.14		
4	Spindel	Spindle	Arbre	Çektirme civatası			15.16.15		
5	Druckstück	Thrust member	Piece recevant la pression	Çelik pul			15.13.20.1		
6	Ritzelschraube	Pinion bolt	Vis de pignon	Pinyon dişli sıkma somunu			15.13.21.1		
7	Ritzel	Pinion	Pignon	Pinyon dişli			15.16.18		
8	Kegelrad	Bevel gear	Rou conique	Ayna dişli			15.16.19		
9	Anlaufscheibe	Thrust washer	Plaque de butee	Teflon pul			15.13.23		
10	O-ring-Ø40x1.5	O-ring-Ø40x1.5	O-ring-Ø40x1.5	O-ring-Ø40x1.5			15.13.24		

#### 15.16.IK

No	Bezeichnung	Type	Désignation	Cinsi	Bestell-Nr.	Order Nr.	Référence	Sipariş Nr.	Euro
1	Hülse	Shell	Douille	Ana gövde			15.16.11.1		
2	Spreizkonus	Spreader cone	Cône d'expansion	İç kovan			15.16.13.1		
3	Spannbacke (1 Satz / 3 Stück)	Clamping jaw (1Set / 3 piece)	Mâchoire de serrage (1 jeu / 3 pieces)	Tırnak (1 Set / 3 adet)			15.13.14		
4	* Spindel	* Spindle	* Arbre	* Çektirme civatası			15.16.16		
5	Druckstück	Thrust member	Piece recevant la pression	Çelik pul			15.13.20.1		
6	Ritzelschraube	Pinion bolt	Vis de pignon	Pinyon dişli sıkma somunu			15.13.21.1		
7	Ritzel	Pinion	Pignon	Pinyon dişli			15.16.18		
8	Kegelrad	Bevel gear	Rou conique	Ayna dişli			15.16.19		
9	Anlaufscheibe	Thrust washer	Plaque de butee	Teflon pul			15.13.23		
10	O-ring-Ø40x1.5	O-ring-Ø40x1.5	O-ring-Ø40x1.5	O-ring-Ø40x1.5			15.13.24		
12	Dichtscheibe	Gasket	Rondelie d'étancheite	Polyemid pul			15.16.23		

#### 15.16.K

No	Bezeichnung	Type	Désignation	Cinsi	Bestell-Nr.	Order Nr.	Référence	Sipariş Nr.	Euro
1	Hülse	Shell	Douille	* Ana gövde			15.16.12.1		
2	Spreizkonus	Spreader cone	Cône d'expansion	İç kovan			15.16.13.1		
3	Spannbacke (1 Satz / 3 Stück)	Clamping jaw (1Set / 3 piece)	Mâchoire de serrage (1 jeu / 3 pieces)	Tırnak (1 Set / 3 adet)			15.13.14		
4	Spindel	Spindle	Arbre	Çektirme civatası			15.16.15		
5	Druckstück	Thrust member	Piece recevant la pression	Çelik pul			15.13.20.1		
6	Ritzelschraube	Pinion bolt	Vis de pignon	Pinyon dişli sıkma somunu			15.13.35.1		
7	Ritzel	Pinion	Pignon	Pinyon dişli			15.16.18		
8	Kegelrad	Bevel gear	Rou conique	Ayna dişli			15.16.19		
9	Anlaufscheibe	Thrust washer	Plaque de butee	Teflon pul			15.13.23		
10	O-Ring-Ø40x1.5	O-Ring-Ø40x1.5	O-Ring-Ø40x1.5	O-ring-Ø40x1.5			15.13.24		
11	Kugel	Ball	Bille	Su gözü			15.16.33		
12	* Senkschraube	* Countersunk head screw	* Vis á tête conique	*Su gözü sıkma civatası			15.16.34		



## Tischwerkzeuggestell

Verschweißte, lackierte Stahlblechkonstruktion  
Werkzeugaufnahmen mit Kunststoffeinsätzen

Benchtop tool shelf, made of welded sheet steel,  
with plastic tool holders

Support de table pour outils  
Fabrication soudée, vernie en tôle d'acier  
Insert d'outil en plastique

Masa üstü takım sehpaı, takım tutucu yeri plastik

Bestell-Nr. Order Nr. Référence Sipariş Nr.	Abmessung Size Dimension Cinsi	Anzahl Einsätze Inserts Takım Adedi	B	T	H	Euro
793.30	SK 30	21	700	400	500	
793.40	SK 40	18	700	400	500	
793.50	SK 50	15	700	400	500	

794.16	VDI 16	21	700	400	500	
794.20	VDI 20	21	700	400	500	
794.25	VDI 25	21	700	400	500	
794.30	VDI 30	21	700	400	500	
794.40	VDI 40	18	700	400	500	
794.50	VDI 50	15	700	400	500	

795.32	HSK 32	21	700	400	500	
795.40	HSK 40	21	700	400	500	
795.50	HSK 50	21	700	400	500	
795.63	HSK 63	18	700	400	500	
795.80	HSK 80	15	700	400	500	
795.100	HSK 100	15	700	400	500	

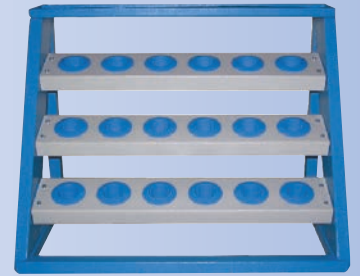
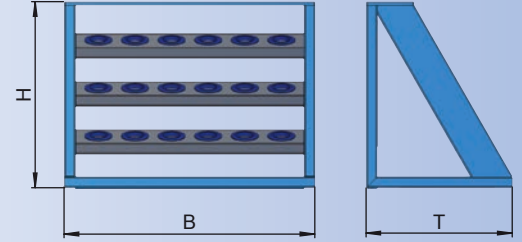

## Transport - und Werkzeugwagen



Verschweißte, lackierte Stahlblechkonstruktion  
2 Bockrollen und 2 Lenkrollen mit Feststeller  
Werkzeugaufnahmen mit Kunststoffeinsätzen

Benchtop tool shelf, made of welded sheet steel,  
2 Steering castors and 2 fixed castors with  
locking device, plastic tool holders

Support de table pour outils  
Fabrication soudée, vernie en tôle d'acier  
2 pieds fixes, 2 pieds de guidage avec linguet  
Insert d'outil en plastique

Taşınabilir çift taraflı takım arabası, dönerli, kilitlenen  
ve sabit tekerlekli, takım tutucu yeri plastik

Bestell-Nr. Order Nr. Référence Sipariş Nr.	Abmessung Size Dimension Cinsi	Anzahl Einsätze Inserts Takım Adedi	B	T	H	Euro
790.30	SK 30	70	700	600	1260	
790.40	SK 40	60	700	600	1260	
790.50	SK 50	50	700	600	1260	
791.16	VDI 16	70	700	600	1260	
791.20	VDI 20	70	700	600	1260	
791.25	VDI 25	70	700	600	1260	
791.30	VDI 30	70	700	600	1260	
791.40	VDI 40	60	700	600	1260	
791.50	VDI 50	50	700	600	1260	
792.32	HSK32	70	700	600	1260	
792.40	HSK40	70	700	600	1260	
792.50	HSK50	70	700	600	1260	
792.63	HSK63	60	700	600	1260	
792.80	HSK80	50	700	600	1260	
792.100	HSK100	50	700	600	1260	

